

R. Lang Company



TRU-FRAME®

A name you can build on.

Manufacturers of Tru-Frame® Quality Home
Improvement Products

800 • 677 • 5264



TABLE OF CONTENTS

SECTION A

Screen Doors	1
Pet Doors	6
Screen Door Order Forms	9

SECTION C

Security Doors	11
Viewguard™ Doors	12
Tru-View Hinged Security Screen Doors	14
Tru-Frame® Security Screen Doors	16
Sliding Security Screen Doors	18
Security Door Components	22
Security Door Order Forms	24

SECTION D

Sliding Patio Screen Doors - Made to Order	29
Sliding Patio Screen Door - KD Kits	34
Screen Door Components	38
Patio Screen Door Order Forms	41

SECTION E

Protecto Grilles	43
Protecto Grille Order Forms	45

SECTION F

Screen Roll Goods (<i>Phifer</i>)	47
Spline	52

SECTION G

Screen Frame	55
Screen Frame Corners	58
Screen Frame Components	59

SECTION H

Aluminum Frame Window Screens	63
Wicket & Pass-Thru Screens	64
Custom Shape Window Screens	65
Window Screen Hardware	66
Architectural Screens	67
Window Screen Order Form	68



TRU-FRAME®
A name you can build on.

TABLE OF CONTENTS

SECTION K

Vinyl Greenhouse Windows	69
Vinyl Greenhouse Window Retro-Fit	71
Vinyl Greenhouse Window Accessories	72
Vinyl Greenhouse Window Order Forms	75

SECTION L

Custom Shapes Skylights	77
Fixed Acrylic Skylights	78
Operable Acrylic Skylights	79
Fixed Flat Glass Skylights	80
Operable Flat Glass Skylights.....	81
Replacement Domes	83
Flashing Kits.....	84
Electric Motors & Accessories	85
Sylight Order Forms	86

SECTION M

Color Match Spray Paints / Fasteners & Screws / Misc	89
--	----

SECTION R

Roll-Away® 2000 Series	93
Roll-Away® 4000 Series	96
Roll-Away® 6000 Series Inside Mount.....	98
Roll-Away® 6500 Series Surface Mount	100
Roll-Away® 7000 Series Inside Mount.....	102
Roll-Away® 7500 Series Surface Mount	104
Roll-Away® Order Forms	106



TRU-FRAME®
A name you can build on.

1. PRICING

All prices are subject to change without notice. Prices in effect at the time of shipment prevail.

2. QUANTITY PRICING

Quantity price breaks are available. Refer to each product section for requirements on accumulation and compilation of products for quantity pricing.

3. TERMS

Invoices are due in full at terms agreed upon at time of order. All past due invoices are subject to a charge of 1.5% per month (18% per year) on the past due balance. A past due balance must be paid in full before the next order is shipped unless prior arrangements have been made. If you wish to open an account with us, complete and return the attached credit application. Please allow ample time for processing.

4. ORDERING

When ordering, please supply our catalog number. Orders are accepted dependent upon availability of merchandise; we are not responsible for delays caused by strikes, material shortage or other conditions beyond our control.

5. MINIMUM ORDERING REQUIREMENT

Due to costs of processing an order, all orders are billed at a minimum of \$40.00.

6. CLAIMS

Title passes to the buyer upon delivery of the goods by R. Lang Company to the carrier by law. Therefore, the buyer must file all claims for damage or loss in transit with the carrier. Claims for all defective merchandise or an error in filling an order **must be reported within five (5) working days** after receipt of the shipment.

7. RETURNED ITEMS

Merchandise may be returned only with R. Lang Company authorization. Authorized returns must be made within 30 days of approval and sent to the factory pre-paid. All returns must be in their original packaging and the same condition in which it was shipped. A 20% restocking charge will be imposed on STOCK items, NON-STOCK items will be charged a 40% re-stock fee. Building Codes vary greatly between States and Counties, and R. Lang Company cannot be held liable for knowing a customer's specific regulations or product application. It is up to the builder/contractor/architect to verify products are within compliance before order is placed.

NOTE: Specials may not be returned.



TRU-FRAME®
A name you can build on.



TRU-FRAME®
A name you can build on.

8. BACKORDERS

The R. Lang Company strives to maintain an adequate stock for its customers' needs. The R. Lang Company will ship all items ordered when available, unless otherwise requested. Backorders will be shipped under the same terms and conditions agreed to on the original order from which the backorder resides. Please contact our customer service desk if you don't wish to have backorders processed.

9. SPECIALS

Cannot be cancelled or returned. R. Lang Company will NOT assume any responsibility for errors in phone orders for specials unless a formal confirmation is completed prior to processing the order. Special Order Confirmations are submitted by R. Lang Company and should be reviewed for their complete accuracy, signed, and returned. ANY questions with regard to the order or its confirmation must be addressed prior to R. Lang processing the order. Returns will NOT be accepted by R. Lang for Special Orders, therefore the order confirmation process should be followed with EACH special order. COD accounts can only place special orders when payment is made in advance of the order being processed.

10. R. LANG ROUTE DELIVERY AND SURCHARGE FEES

The R. Lang Company schedules deliveries utilizing its trucking fleet throughout many parts of California, Arizona and Nevada. A surcharge is assessed on all deliveries made by the R. Lang Company. The surcharge, based on the value of all items/orders delivered on one given shipment, is listed below. Surcharge amounts can vary depending on market conditions including current oil/gas prices. The R. Lang Company will give fifteen (15) days advance notification whenever an adjustment to the surcharge amount is required. To determine when delivery is scheduled in your area, please contact your customer service representative.

Minimum Surcharge: 8% of the value of all items being delivered on one given shipment or \$25.00, whichever is greater (see Maximum Surcharge below).
All deliveries will be assessed a \$25.00 surcharge at a minimum.

Maximum Surcharge: At no time, despite the value of all items being delivered on one given shipment, shall a surcharge ever exceed \$90.00.

Note: ALL deliveries made by R. Lang Company are subject to the surcharge amounts as listed above.

Will Calls Only: Will Calls are available at our Visalia, California facility during normal working hours, Monday - Friday, from 8:00 A.M. to 4:30 P.M.
8240 W. Doe Avenue, Visalia, CA 93291

**SHIPPING TERMS
& CONDITIONS**

11. FREIGHT & F.O.B. POINTS

All prices are quoted F.O.B. Visalia, CA. Orders not qualified for delivery (see #10) will be shipped "Common Carrier", "UPS", or "Fed-Ex" (see #12).

12. FREIGHT ALLOWANCES

Orders not qualified for delivery (see #10) will be shipped under the following terms. Orders exceeding the pre-paid order amounts listed below, exclusive of tax, and directed to a single destination will be shipped freight pre-paid. R. Lang Company will select the carrier / method utilized for the delivery when the shipment meets the criteria as outlined. Customer may specify shipping carrier / method only when assuming all associated freight costs directly.

12a. RESIDENTIAL FEES / LIFT GATE SERVICES

The R. Lang Company does NOT cover added 'Residential Delivery' fees and/or 'Lift Gate Service' fees sometimes added by Common Carrier/Freight Service Groups even when order(s) being delivered qualify for Pre-Paid delivery (see #10-12). ONLY the base shipping charge will be pre-paid by R. Lang Company, all other Freight Charges incurred will be billed back to Customer.

COMMON CARRIER SHIPMENTS		UPS/FED-EX ONLY
SHIPPING LOCATION	PRE-PAID ORDER AMOUNT	PRE-PAID ORDER AMOUNT
CALIFORNIA	\$1500	\$500
WESTERN REGION	\$3000	\$750
MIDWEST REGION	\$5000	\$1500
EASTERN REGION	\$5000	\$1500
ALASKA	\$5000	\$1500



Packaging Chart - Common Carrier/UPS Carton Fees

Section	Product	Pack Qty Carrier	Pack Qty UPS/Other	Pack Charge (Net)
A	Screen Doors	4		\$11.00
C	C514 Tru-Frame® & C654 TruView®	2		\$11.00
C	C614 ViewGuard & C714 Slider	1		\$11.00
D KD Kits	D150, D200, D275	6	2	\$9.00
D KD Kits	D350, D500	6	2	\$9.00
D Assembled	D100, D200, D250, D275	6		\$11.00
D Assembled	D350 Primacy	2		\$11.00
D Assembled	D500 Legacy	4		\$11.00
E	Protecto Grilles	12	12	\$11.00
F	Screen Rolls	8	4	\$11.00
G	Screen Frame - Full Boxes (Pcs)	1 (10)	(10)	\$11.00
H	Window Screens (size/shape dependent)	Quote	Quote	\$10.00
J/K	Greenhouse Window Assembled	1		\$75.00
L	LC & LLA (Skylights over 48 x 48 = x2)	1 (2)	Quote	\$15.00
L	LO, LCG, LOG, LNL, LT, LTR (over 48 x 48 = x2)	1 (2)	Quote	\$15.00
Lineals	Lineal Shapes up to 84" In Length (over 84" in Length)	25 (25)	Quote	\$20.00
Misc	Boxing Charge up to 10" x 10" x 10"	Quote	Quote	\$6.00
Misc	Boxing Charge up to 12" x 12" x 12"	Quote	Quote	\$6.00

Note: In order to better protect products NOT shipping via R. Lang Company's Route Delivery (our trucks), we must utilize added packaging. These packing charges will be added to ANY orders delivered via Common Carrier / UPS (or similar). Due to weight & size restrictions, some items MUST ship Carrier. Your order confirmation will show all expected pack charges.



TRU-FRAME®
A name you can build on.

CO-OP ADVERTISING PROGRAM - HOME IMPROVEMENT PRODUCTS

PARTICIPATION AND LIMITS OF REIMBURSEMENT

- Subject to the conditions, which follow, the R. Lang Company will pay up to 50% of the cost of local advertising of Tru-Frame® home improvement products and selected other items.
- The R. Lang Company's portion of reimbursement is limited to 2% of the net purchases of the previous year.
- The co-op calendar year runs from January 1 through December 31. Claims must be received by January 31st of the following year to receive credit for the prior calendar year. The unused portion of a customer's co-op fund will not be carried over to the next year.

PRODUCTS

- Products subject to the 50% cost reimbursement.
 - Swinging screen doors
 - Sliding screen doors
 - Security doors
 - Sliding Security doors
 - Roll-Away®
 - Skylights
 - Greenhouse windows
 - SunScreen®
 - Suntex®
 - Replacement window & door hardware
 - Grilles

ELIGIBILITY

- Home centers, retail lumber and hardware stores, glass shops, screen fabricators or other retail outlets, which purchase the above-named products, are eligible.

QUALIFICATIONS

- To qualify for reimbursement, the ad must:
 1. Feature one or more of the products listed above;
 2. Prominently feature the R. Lang Company's logo and name;
 3. Be illustrated by ad slicks provided by the R. Lang Company or approved alternative;
 4. Make no claims that the R. Lang Company does not make in its own advertising;
 5. Include no products of competing companies in the same ad;
 6. Comply with the terms specified under "**Media.**"

MEDIA

- This cooperative advertising program is designed for print media, specifically newspapers, newspaper inserts, circulars and catalogs, and Yellow Page phone ads. Newspapers are general circulation daily, weekly and Sunday periodicals, distributed in the principal trading area served by the dealer, qualify for a second class mailing permit, and have published rates and circulation figures which can be verified. Newspaper inserts are special advertising supplements and inserted into paid, general circulation newspapers. Circulars are direct mail advertisements distributed through the postal service. Catalogs are bound or stapled booklets of quality paper stock distributed for special event advertising. **Alternative advertising must have advance, written approval of the R. Lang Company.** This program does not include in-store advertising.

SUBMISSION OF CLAIMS

SEND CLAIMS TO:
R. Lang Company
Attn: Co-op Ad Manager
P.O. Box 7960
Visalia, CA 93290

- All claims must include a copy of the paid invoice from the publisher of the ad showing date run, advertising rate, and method of rate calculation (column inch, square inch, etc), and a copy of the ad run. For newspapers and newspaper inserts, a full tear sheet is required for each day the ad runs; it must show the name of the newspaper, the date and the entire ad. For direct mail circulars, provide a copy of the entire circular plus Post Office mail receipts or printer's invoice verifying circulation. Production costs are not eligible for co-op credit. Only that portion of an ad, which contains copy directly related to R. Lang Company products, is eligible for co-op credit. **All qualified requests should be submitted at one time before January 31st for prior year co-op fund.**

REIMBURSEMENT

- Reimbursement will be in the form of a credit to the customer's account.

STANDARD PAINT COLORS

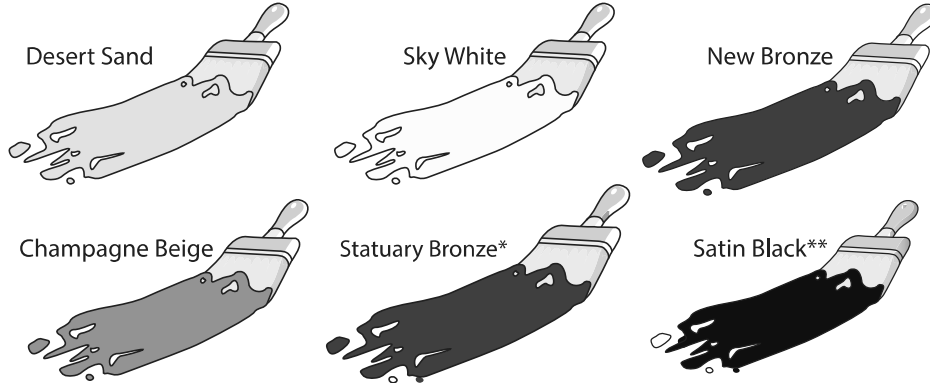

* Statuary Bronze is standard color for Section E Grilles and J-Greenhouse Windows only.

ANODIZED FINISHES



SPECIAL PAINT COLORS

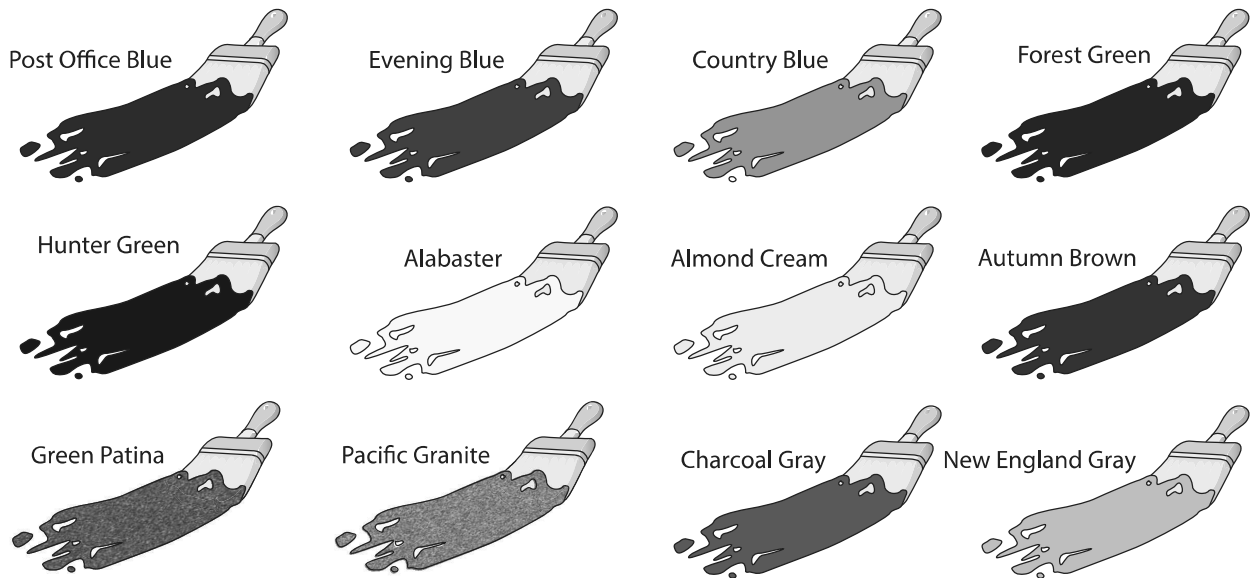

RAL PAINT COLORS



NOTE: The colors shown here are not a perfect match, they are only offered as an approximation of actual colors and are subject to change. Paint chip samples are available by calling one of our customer service representatives at 800-677-5264.



TRU-FRAME®
A name you can build on.



Screen Door Display

Holds up to **10-Doors** with signage and pins (36" x 80" doors sold separately). See Section A (Screen Doors) for styles and colors available.

ADS100BL

List: \$1,512.50

*Please refer to page 1, Section A for specific finish and color combinations. Doors sold separately.

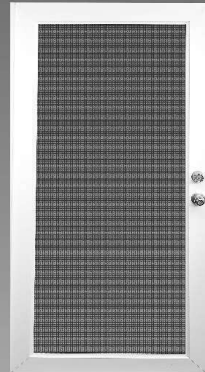

Viewguard™ Display

Viewguard™ Security Full size (free standing) door display. Includes: Door, Stand & Sign. Only available in white.

C614WHSMPL-DISPLAY

List: \$2,150.00



Screen Door Mini Display

5-Door Mini Display with signage and pins (16" x 32" doors sold separately). See Section A (Screen Doors) for styles and colors available.

ADS050BL

List: \$544.50

*Please refer to page 1, Section A for specific finish and color combinations. *Doors sold separately.

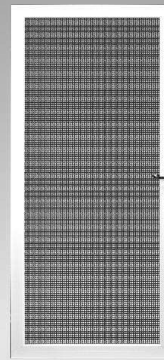

TruView® Display

TruView® Full size (free standing) door display. Includes: Door, Stand & Sign. Only available in white.

C654WHSMPL-DISPLAY

List: \$1,700.00



Patio Door Mini Display

Patio mini door Display with signage and pins (16" x 32" doors sold separately). See Section D (Sliding Screen Doors) for styles and colors available..

DDS050BL

List: \$595.00

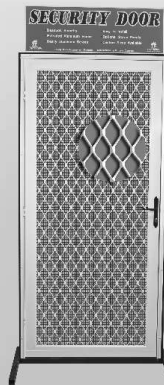

Security Door - Display

Tru-Frame® Security Door Full Size (free standing) door display. Includes: Door, Stand & Sign. Only available in white.

C514WHSMPL-DISPLAY

List: \$1,550.00

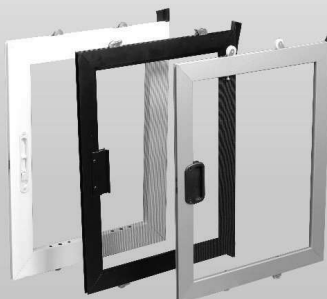

Hand Samples - 16" x 32"

Hand Samples

Available in nearly any Screen Door or Patio Sliding Screen Door model. Please see Section A (Screen Doors) and Section D (Sliding Screen Doors) for specific pricing..

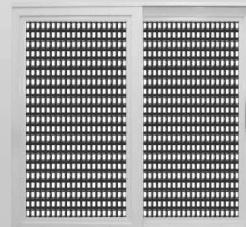

Security Slider Mini Sample

Security Slider Screen Door 1/2 Size (48" X 46" free standing) door display. Includes: Door, Stand & Sign. Only available in white.

C774WHSMPL48

Single Door: \$950.50
Double Door: \$1250.00



Roll-Away® 4000 - Mini

Roll-Away® 4000 - R40XX0100 Mini counter sample. Available in the following colors*
Overall size 17.5"X21.5"

List: \$174.00

*White (WH), Satin (SA), Desert Sand (DS), Champagne Beige (CB), Black (BL), Bronze (BR)



Roll-Away® 6000 or 7000 - Mini

Roll-Away® 6000 or 7000 Mini counter sample. Available in the following colors*

Single (As Shown) 17.5"X21.5" List: \$213.50
French Set 21.5" X 30" List: \$299.00

*White (WH), Satin (SA), Desert Sand (DS), Champagne Beige (CB), Black (BL), Bronze (BR)



Roll-Away® 6000 - Full size

*Roll-Away® 6000- R600WHSMP*L Full size (free standing) display includes...Door, Stand, & Sign., Only available in white.

List: \$830.50

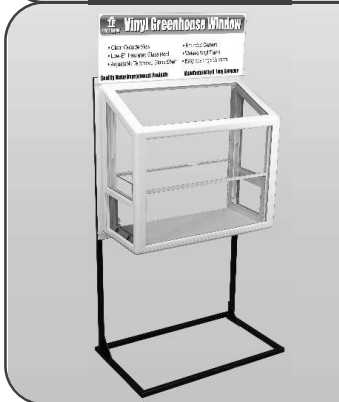

Vinyl Greenhouse Window

Vinyl Greenhouse Window Display with signage includes KI3030WH Greenhouse Window, sign & stand. Only available in white

KDS1000

List: \$1,600.00

Did you know?

Each **Tru-Frame®** greenhouse window features a tough, durable frame in white or almond color that never needs painting, and is maintenance free. With rounded corners they're safer to have around your house because the edges don't protrude.



Skylight Display

Skylight display rack with signage. Skylights are sold separately. See Section L (Skylights) for styles and colors available.

LDS100BL

List: \$1,441.00

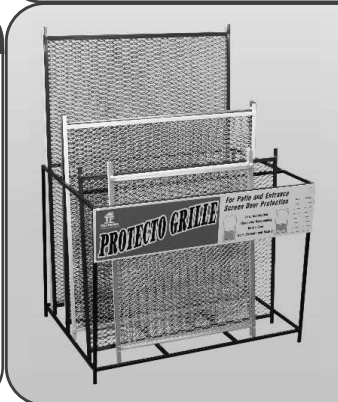

Grille Display

Protecto Grille display with signage. Grilles are sold separately, see Section E (Grilles and Accessories) for styles and colors available.

EDS100BL

List: \$600.00

















TRU-FRAME®
A name you can build on.





























TRU-FRAME®
A name you can build on.

SECTION A

	Marina - A220		Riviera - A200
	<p> 2-1/8" X 3/4" Extruded Frame (2) 1-1/4" Extruded Push Bars 12" Kickplate 18 x 16 Phifer Insect Screen Stainless Steel Hinges (3) Fiesta Grille Sizes: 3/0, 2/8, 2/6 Max. Size 48" x 108" </p>		<p> 2-1/8" X 3/4" Extruded Frame (2) 1-1/4" Extruded Push Bars 12" Kickplate 18 x 16 Phifer Insect Screen Stainless Steel Hinges (3) Fiesta Grille Sizes: 3/0, 2/8, 2/6 Max. Size 48" x 108" </p>
<p> BA  - \$401.00 BR  - \$336.50 CB  - \$336.50 DS  - \$336.50 SA  - \$351.00 WH  - \$336.50 </p>		<p> BA  - \$401.00 BR  - \$336.50 CB  - \$336.50 DS  - \$336.50 SA  - \$351.00 WH  - \$336.50 </p>	

	Aspen - A214		Monterey - A270
	<p> 2-1/8" X 3/4" Extruded Frame (3) 1-1/4" Extruded Push Bars 12" Kickplate 18 x 16 Phifer Insect Screen Stainless Steel Hinges (3) Skip Mesh Grille Sizes: 3/0, 2/8, 2/6 Max. Size 36" x 108" </p>		<p> 2-1/8" X 3/4" Extruded Frame (2) 1-1/4" Extruded Push Bars 12" Kickplate 18 x 16 Phifer Insect Screen Stainless Steel Hinges (3) Amplimesh Grille Sizes: 3/0, 2/8, 2/6 Max. Size 42" x 108" </p>
<p> BR  - \$351.50 CB  - \$351.50 DS  - \$351.50 WH  - \$351.50 </p>		<p> BA  - \$459.50 BR  - \$398.50 CB  - \$398.50 DS  - \$398.50 WH  - \$391.00 </p>	

	Colonial - A290		Full View - A280
	<p> 2-1/8" X 3/4" Extruded Frame Extruded Grid Pattern 18 x 16 Phifer Insect Screen Stainless Steel Hinges (3) Sizes: 3/0, 2/8, 2/6 Max. Size 48" x 96" A290 w/6" Kickplate (A295) Add: \$10.00 List </p>		<p> 2-1/8" X 3/4" Extruded Frame 6" Kickplate 18 x 16 Phifer Insect Screen Stainless Steel Hinges (3) Sizes: 3/0, 2/8, 2/6 Max. Size 48" x 96" A280 w/ 2 Pushbars Add: \$17.50 List A280 w/12" Kickplate Add: \$15.00 List </p>
<p> BR  - \$350.50 CB  - \$350.50 DS  - \$350.50 WH  - \$350.50 </p>		<p> MF  - \$240.50 BA  - \$328.00 BR  - \$273.00 CB  - \$273.00 DS  - \$273.00 SA  - \$288.00 WH  - \$273.00 </p>	

See page 4 for Door Hardware and Screening Options



TRU-FRAME®
A name you can build on.

OPENING WIDTHS FOR STANDARD SIZE SCREEN DOORS:

	Hinge Expander Style	Pre Hung Style
Stock Size	Fits Opening Width	Fits Opening Width
30" x 80"	29-3/4" to 30-5/8"	29-7/8" to 30-1/4"
32" x 80"	31-3/4" to 32-5/8"	31-7/8" to 32-1/4"
36" x 80"	35-3/4" to 36-5/8"	35-7/8" to 36-1/4"

NOTE: All doors fit an Opening Height of 79-3/4" to 81-1/4".
See Page 8 for Illustrated Details of Installation Methods.

HOW TO MEASURE OPENING FOR SPECIAL SIZE DOORS:

When ordering **Special Size Screen Doors**, please specify the **OPENING SIZE (OS)** to the nearest 1/8". The standard deductions taken from the opening size to arrive at the **NET SIZE (NS)** are width minus 3/4" and height minus 3/4". This will allow for proper fit of an extruded door.

EXAMPLE:

If the special size dimensions are 38" x 82" Opening Size (OS), the door manufactured will be 37-1/4" x 81-1/4" Net Size (NS).

NOTE: All screen doors are individually shrink wrapped with hardware included.

EXTRUDED FRAME SPECIAL SIZE SCREEN DOORS:

Special size screen doors are available. See page 2 for size limitations on specific models. Add the following set-up charges to the LIST PRICE on Special Size EXTRUDED FRAME models:

Special Width - \$35.00

Special Height - \$35.00

Special Width & Height - \$60.00

Extruded doors come with 3 hinges and a bottom expander with bug strip. Add \$10.00 to List Price for each additional hinge required.

Pre-Hung Z-bar frames are available as a special order. (Call Factory For Details) Specify LH (hinged left) or RH (hinged right) on single doors (viewed outside looking in). **Add \$50.00 to LIST PRICE for Pre-Hung Doors.**

PACKAGING: See Packaging Chart located in "Shipping Terms and Conditions" to calculate Packaging Fees for orders shipping Common Carrier.

RETURN POLICY: Special Order Doors manufactured to the customer's specifications MAY NOT BE RETURNED OR CANCELLED for any reason.

Standard size doors are subject to approval and a restock fee. **No returns after 30 days.**



TRU-FRAME®
A name you can build on.

SCREENING OPTIONS

Add the following to the LIST PRICE of each SCREEN DOOR for substitutions:

<u>VISION ENHANCING</u>	<u>SUN CONTROL</u>	<u>PET CONTROL</u>	<u>METAL MESH</u>
18 x 16 - Included!	Suntex 80% - \$38.00	Tuff Screen - \$30.00	Brite Aluminum - \$16.00
BetterVue - Free Upon Request	Suntex 90% - \$47.00	Pet Screen - \$35.00	Charcoal Aluminum - \$17.00
UltraVue - \$25.00	Super Solar 90% - \$47.00	-	Brite Bronze - \$80.00
No-See-Um - \$35.00		-	
18X14 Fiberglass - \$15.00		-	-

Standard Hardware



Standard Hardware kit with closer and all installation screws included with every door.

A1190BL	Black	\$48.50
A1193BL	Black	\$37.50
A1193WH	White	\$37.50
A1193SA	Gray	\$37.50



TRU-FRAME®
A name you can build on.

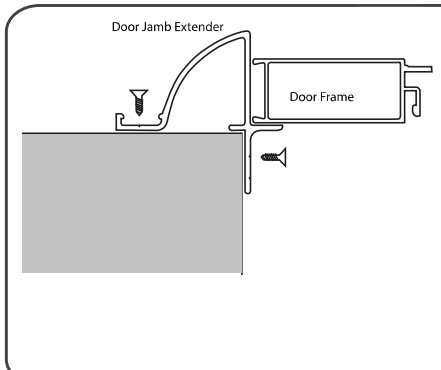

DOOR JAMB EXTENDER KIT

(For Hinge Expander Style Doors Only)

A15110	<input type="checkbox"/> SA or <input type="checkbox"/> DS <input type="checkbox"/> WH <input type="checkbox"/> CB <input type="checkbox"/> BR	-	\$119.00
A15111	<input type="checkbox"/> SA or <input type="checkbox"/> DS <input type="checkbox"/> WH <input type="checkbox"/> CB <input type="checkbox"/> BR	-	\$139.00

- A15110 - Single Door Jamb Extender Kit**
- 2 - Jambs at 85-1/2" (for opening to 84")
 - 1 - Header at 40" (for opening to 36")
 - 11 - Sheet metal screws (for hinges)
 - 16 - #10 x 1-1/2" phil pan head screws

- A15111 - Double Door Jamb Extender Kit**
- 2 - Jambs at 85-1/2" (for opening to 84")
 - 1 - Header at 76" (for opening to 72")
 - 18 - Sheet metal screws (for hinges)
 - 19 - #10 x 1-1/2" phil pan head screws

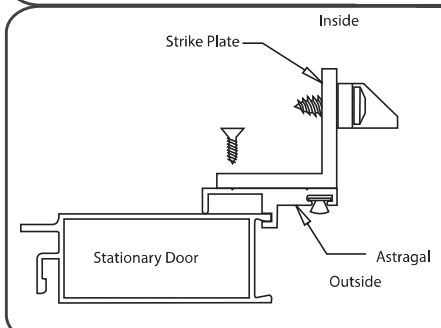

FRENCH DOOR ASTRAGAL KIT

A15071	<input type="checkbox"/> MF <input type="checkbox"/> BA <input type="checkbox"/> SA or <input type="checkbox"/> DS <input type="checkbox"/> WH <input type="checkbox"/> CB <input type="checkbox"/> BR	\$65.50
A15070	<input type="checkbox"/> MF <input type="checkbox"/> BA <input type="checkbox"/> SA or <input type="checkbox"/> DS <input type="checkbox"/> WH <input type="checkbox"/> CB <input type="checkbox"/> BR	\$72.00
A15100BL (Black)		\$26.00

A15071 - French Screen Door Kit 84"

- 1 - Extruded Astragal 84"
- 1 - Special Strike Plate & Shim
- 2 - Slide Bolts with screws
- 1 - Instruction Sheet

A15070 - French Screen Door Kit 96"

- 1 - Extruded Astragal 96"
- 1 - Special Strike Plate & Shim
- 2 - Slide Bolts with screws
- 1 - Instruction Sheet

A15100 - French Door Slide Bolt (Black)



RIVIERA SCREEN DOOR KD KITS

PART NO.	DESCRIPTION	<input type="checkbox"/> SA	<input type="checkbox"/> BA	<input type="checkbox"/> DS <input type="checkbox"/> WH
		A200##K36	KD Kit 36" x 84"	\$329.50
A200##K42	KD Kit 42" x 84"	\$346.00	\$397.00	\$343.00
A200##K48	KD Kit 48" x 84"	\$373.00	\$426.00	\$367.50

RIVIERA KD KIT INCLUDES:

- Extruded door frame 2-1/8" x 3/4" x .050
- Extruded 1-1/4" pushbar (2) meeting rail (1)
- Extruded 3/4" bottom & hinged channels
- Extruded corner locks with screws
- Expanded metal Fiesta pattern grille
- Pull Handle hardware set with closer
- Diamond embossed 12" kickplate



FULL VIEW SCREEN DOOR KD KITS

PART NO.	DESCRIPTION	<input type="checkbox"/> SA	<input type="checkbox"/> BA	<input type="checkbox"/> DS <input type="checkbox"/> WH
		A280##K36	KD Kit 36" x 84"	\$265.00
A280##K42	KD Kit 42" x 84"	\$291.00	\$333.00	\$296.00
A280##K48	KD Kit 48" x 84"	\$308.00	\$349.00	\$327.00

FULL VIEW KD KIT INCLUDES:

- Extruded door frame 2-1/8" x 3/4" x .050
- Extruded 1-1/4" meeting rail (1)
- Extruded 3/4" bottom & hinged channels
- Pull Handle hardware set with closer
- Diamond embossed 6" kickplate

Available Colors: Mill Finish (), Satin Anodized (), Bronze Anodized ()

Painted Finishes: Bronze (), White (), Champagne Beige (), Desert Sand ()

NOTE: The ## in the part numbers above represent available finishes. Replace ## with your choice of color.

96" KD Kits available as special order - Add \$40.00 to list price

NOTE: Additional screen door components available. Please contact our Customer Service Department if you have any questions.



TRU-FRAME®
A name you can build on.

PET DOORS

Made of heavy duty aluminum extrusions for strength, ease of installation, with a secure closing method. Two way rubber will not freeze, crack, warp or become sticky. Thumb locked closing panel is covered in a white laminate so that pets will know they cannot pass through. No sharp edges and all weather protected with four different colored finishes. Mounts into wooden & aluminum doors, or use with screen door adapter.



SIZE	PART NO.	BR SA TN WH	FLAP SIZE	LIST PRICE
SM	A1227		4-3/4" x 7-1/8"	\$107.50
MD	A1228		8-1/2" x 12-1/2"	\$152.00
LG	A1229		11-1/2" x 16-7/8"	\$202.50
XL	A1226		14-1/2" x 19-1/2"	\$273.00

SCREEN DOOR ADAPTERS FOR PET DOORS

Made of an extruded frame which fits onto the sliding screen door frame making it possible to install a pet door. Provides a very strong, attractive and convenient place to put a pet door. Ends screen door destruction, is inexpensive, and easy to install.

**For use with the A1227, A1228, A1229, and A1226 Pet Doors (listed above).*

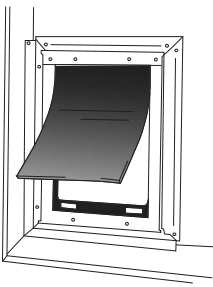

SIZE	PART NO.	BR SA TN WH	OVERALL SIZE	LIST PRICE
SM	A1235		10-5/8" x 12-3/4"	\$50.00
MD	A1236		14-1/8" x 18"	\$57.00
LG	A1237		17-1/8" x 22-1/16"	\$69.00
XL	A1242		20-3/8" x 24-7/8"	\$75.00
SM	A1238 — SD-300A SM PET DOOR RUBBER REPLACEMENT ASSEMBLY			\$49.50
MD	A1239 — MD-400A MD PET DOOR RUBBER REPLACEMENT ASSEMBLY			\$76.00
LG	A1240 — LD-500A LG PET DOOR RUBBER REPLACEMENT ASSEMBLY			\$137.50
XL	A1241 — XLD-600A XLRG PET DOOR RUBBER REPLACEMENT ASSEMBLY			\$176.50

SLIDING PET DOOR GLASS PANELS

A complete unit including the pet door, for installation into the sliding glass door or screen door track. Adjusts to fit door height openings from 78-1/2" to 81" tall.

The perfect choice for a condo or home, or for renters who cannot make a permanent hole into the structure. Can be installed temporarily or permanently. Complete with a security locking device.

Closing Panel & Channel Adapter included.

Specials available - call factory for quote.



SIZE	PART NO.	BR SA TN WH	FLAP SIZE	LIST PRICE
SM	A1232		4-3/4" x 7-1/8"	\$341.00
MD	A1233		8-1/2" x 12-1/2"	\$432.50
LG	A1234		11-1/2" x 16-7/8"	\$469.00

SCREEN PET DOORS

The pet screen door allows your pet to pass in and out while allowing for ventilation of your home. Installs into any sliding screen door.



PART NO.	DESCRIPTION	FINISH	LIST PRICE
A1224	8" x 10" Pet Door	■ Bronze	\$81.50



TRU-FRAME®
A name you can build on.

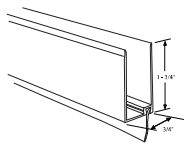

BOTTOM EXPANDERS FOR EXTRUDED DOORS

A2026	MF	-	\$30.50
A2026	BA	-	\$39.00
A2026	SA CB DS BR WH	-	\$34.00

36-1/2" x 3/4" Extruded Bottom Expander with Vinyl Sweep

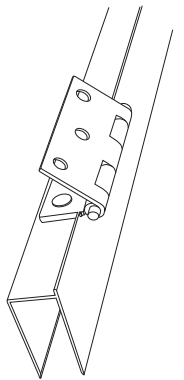

HINGE EXPANDERS FOR EXTRUDED DOORS

A25024	MF	-	\$61.00
A25024	BA	-	\$76.50
A25024	SA WH CB DS BR	-	\$65.00
A25023	MF	-	\$62.00
A25023	BA	-	\$79.50
A25023	SA WH CB DS BR	-	\$66.00
A25022	MF	-	\$66.00
A25022	BA	-	\$83.50
A25022	SA WH CB DS BR	-	\$72.00

80-1/2" x 3/4" Extruded Expander w/ (3) A1170 SS Hinges

84" x 3/4" Extruded Expander w/ (3) A1170 SS Hinges

96" x 3/4" Extruded Expander w/ (4) A1170 SS Hinges

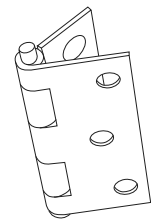

HINGES

A1170	MF SS	-	\$10.00
A1170	BL (SS)	-	\$12.00
A1171	MF SS	-	\$10.00
A1171	BL (SS)	-	\$12.00

Stainless Steel Hinge for Hinge Expander Style Door

Stainless Steel Hinge for Pre-hung Style Door

Available Colors: Mill Finish () , Satin Anodized () , Bronze Anodized ()

Painted Finishes: Bronze () , White () , Champagne Beige () , Desert Sand ()

NOTE: The ## in the part numbers above represent available finishes. Replace ## with your choice of color.



TRU-FRAME®
A name you can build on.

SECTION A

DOOR HARDWARE KITS

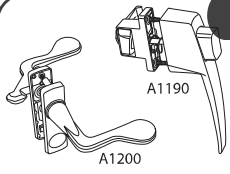

A1190	BL	-	\$48.50
A1193	BL WH SA	-	\$37.50
A1200	BL	-	\$62.00
A1220	BL	-	\$18.00

- Push Button Hardware Kit (Roll Form Door)
- Heavy Duty Closer Hardware Kit (Extruded Door)
- In-Swing Latch - No Closer
- Push Button Key Lock (Extruded Door)

BUG SWEEPERS

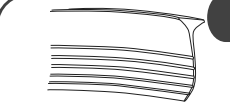

A2332BL	BL	-	\$5.00
A2333BL	BL	-	\$6.00

- Vinyl Bottom Sweep 37-1/2"
- Vinyl Bottom Sweep 48"

FLOOR DISPLAYS & HAND SAMPLES



ADS100	BL	\$1,512.50
ADS050	BL	\$544.50
A200BASMPL (Riviera)		\$152.00
A200##SMPL (Riviera)		\$131.00
A214##SMPL (Aspen)		\$145.00
A270##SMPL (Monterey)		\$168.50
A280##SMPL (Full View)		\$137.50
A290##SMPL (Colonial)		\$158.50

- * Screen Door Display with Sign & Pins (Holds 10 doors). 36" x 80".
- * Mini Screen Door Display with Sign & Pins (Holds 5 doors). 16" x 32".
- * Doors must be purchased separately.
- All Screen Door Hand Samples Measure 16" x 32"
- See 'A Section Page 2' for Door Details and Colors available within each style.

Available Colors: Mill Finish (▨), Satin Anodized (▩), Bronze Anodized (■)
Painted Finishes: Bronze (■), White (□), Champagne Beige (▤), Desert Sand (▥)
NOTE: The ## in the part numbers above represent available finishes. Replace ## with your choice of color.

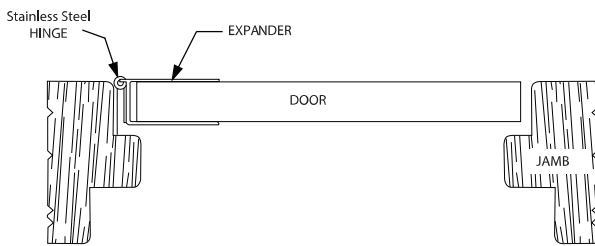

Hinge Expander Installation

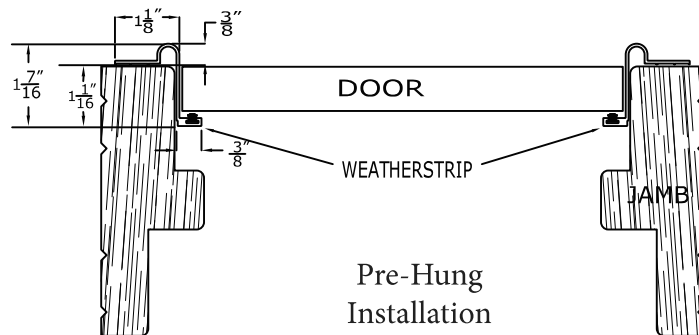

Pre-Hung Installation



ORDER / QUOTE FORM

R. Lang Company

TRU-FRAME®
A name you can build on.

ORDER QUOTE (Check One)

Special "A" Swing Door
Fax Number: 888-526-4329

DEALER: _____

DATE: _____

PO#/JOB NAME _____

Completed by: _____

DOOR STYLE OR ITEM # _____ FINISH _____

QUANTITY _____ OPENING SIZE _____ x _____

OPTIONS:

____ HINGE EXPANDER STYLE

*Hinge Expander is standard

____ PRE-HUNG (Extruded Doors Only)
(Special Order - Add \$50.00 to list)

____ RIGHT HINGE (Outside looking in)

____ LEFT HINGE (Outside looking in)

SCREEN MESH: _____ FIBERGLASS (BetterVue is standard mesh)
_____ ALUMINUM WIRE
_____ OTHER (See Section F for other options)

Special notes: _____

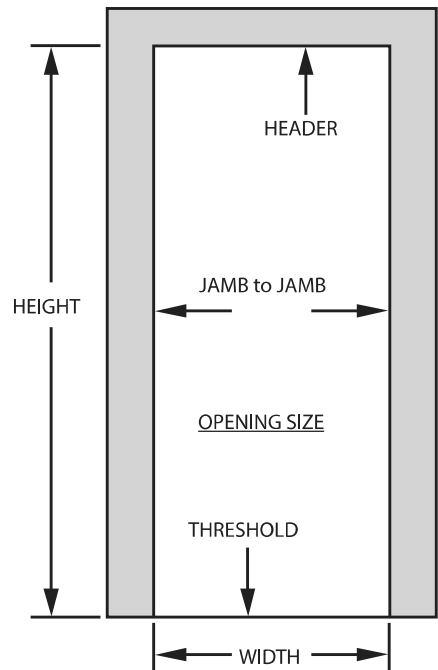

Hinge Expander Style Pre-Hung Style

SIZE	OPENING WIDTH	OPENING WIDTH
30" x 80"	29-3/4" to 30-5/8"	29-7/8" to 30-1/4"
32" x 80"	31-3/4" to 32-5/8"	31-7/8" to 32-1/4"
36" x 80"	35-3/4" to 36-5/8"	35-7/8" to 36-1/4"

NOTES: All **extruded** doors fit an Opening Height of 79-3/4" to 81-1/4"
All **rolled form** doors fit an Opening Height of 79-3/4" to 81"

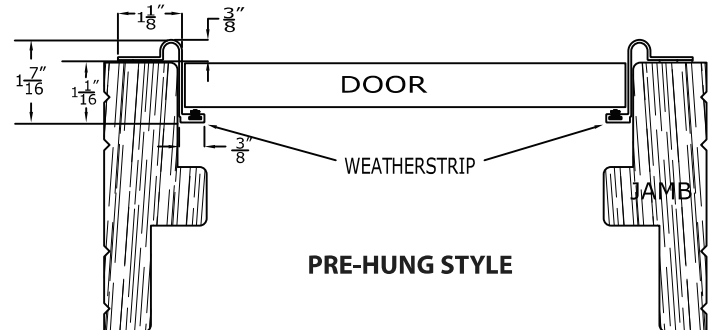
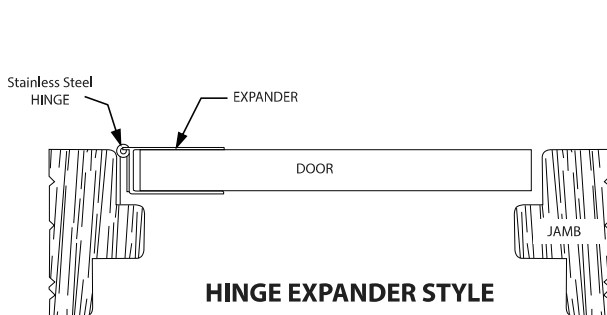



TRU-FRAME®
A name you can build on.

Special "A" Swing French-Door

Fax Number: 888-526-4329

ORDER QUOTE (Check One)

DEALER: _____

DATE: _____

JOB NAME/PO#: _____

Completed by: _____

DOOR STYLE OR ITEM # _____ FINISH _____

QUANTITY _____ OPENING SIZE _____ x _____

OPTIONS:

___ HINGE EXPANDER STYLE (Hinge Expander is standard.)

___ PRE-HUNG (Add \$50.00 to list for each door)

(Outside looking in) ___ OX (Right Door Active)
___ XO (Left Door Active)

- SCREEN MESH:
- ___ BetterVue (Standard)
 - ___ Fiberglass Mesh
 - ___ UltraVue
 - ___ Aluminum Wire (Brite)
 - ___ Aluminum Wire (Charcoal)
 - ___ Suntex 80%
 - ___ Suntex 90%
 - ___ Pet Screen
 - ___ Tuff Screen
 - ___ Sunscreen
 - ___ Super Solar
 - ___ 20x30 Insect
 - ___ Brite Bronze

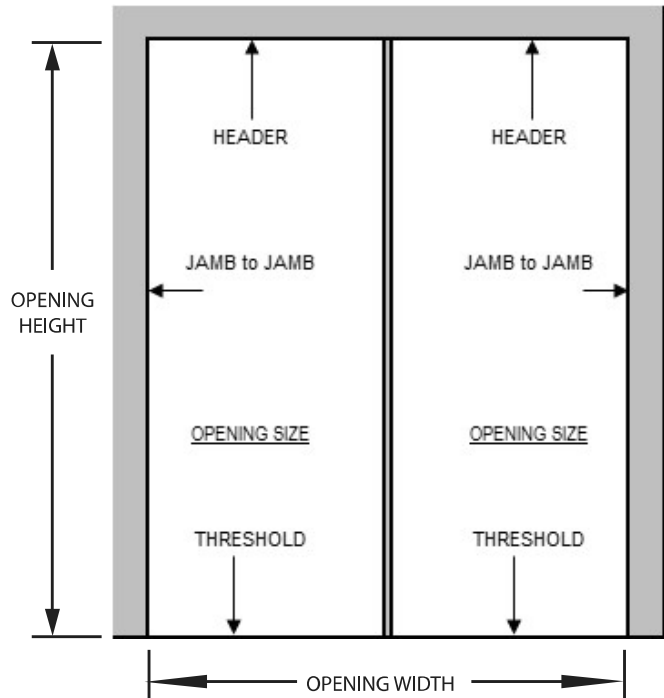

Special notes: _____

Standard Size Tolerances
Opening Size
(Each Door Leaf)

Size	Opening Width	Opening Height
30" X 80"	29-3/4" to 30-5/8"	79-3/4" to 81-1/4"
32" X 80"	31-3/4" to 32-5/8"	79-3/4" to 81-1/4"
36" X 80"	35-3/4" to 36-5/8"	79-3/4" to 81-1/4"

Contact Factory for Size Limitations

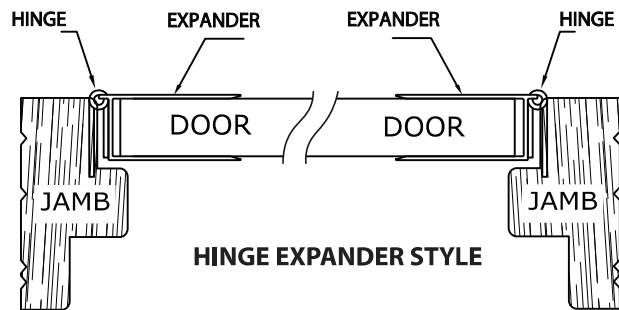



TRU-FRAME®
A name you can build on.

TRU-FRAME®
SECURITY SCREEN DOOR
V I E W G U A R D™



TRU-FRAME®
A name you can build on.



The Key To Security Is Within Your Reach



TRU-FRAME®
A name you can build on.

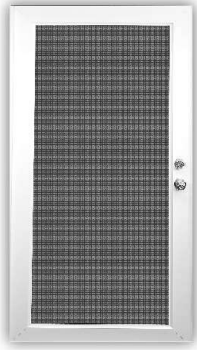

VIEWGUARD™ SECURITY DOOR - C614

PART NO.	Outside Frame Size Max Opening Size	36" x 84" 32" x 82"	36" x 98" 32" x 96"	42" x 84" 38" x 82"	42" x 98" 38" x 96"	48" x 84" 44" x 82"	48" x 98" 44" x 96"
C614BA	Bronze Anodized	\$1,938.50	\$2,191.00	\$1,969.50	\$2,221.00	\$2,438.50	\$2,552.50
C614WH	White Paint	\$1,843.00	\$2,081.00	\$1,869.50	\$2,105.50	\$2,323.00	\$2,420.50

Pre-Hung Heavy-Duty Security Door (Surface Mount Only)

4-5/8" x 1-3/8" x .093 Extruded Aluminum Tubular Door Stiles
1-7/8" x 1-9/16" x .093 Extruded Aluminum 3-Sided Surround

316 Series Stainless Steel Mesh - 12 x 12 x .032
Continuous geared hinge runs full length of door stiles

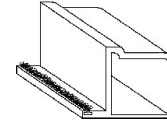

Outside Surround Frame
See Detail on Next Page

VIEWGUARD™ FRENCH SECURITY DOOR - C634

PART NO.	Outside Frame Size Max Opening Size	72" x 84" 68" x 82"	72" x 98" 68" x 96"	84" x 84" 80" x 82"	84" x 98" 80" x 96"	96" x 84" 92" x 82"	96" x 98" 92" x 96"
C634BA	Bronze Anodized	\$3,833.00	\$4,308.00	\$4,805.50	\$5,003.00	\$5,035.00	\$5,097.50
C634WH	White Paint	\$3,627.00	\$4,071.00	\$4,560.00	\$4,734.50	\$4,765.50	\$4,817.50

Pre-Hung Heavy-Duty French Security Door (Surface Mount Only)

Includes 2 Viewguard™ Doors (Above) and complete
3-Sided Surround Frame & Astragal for French Door Application.
Specify OX or XO (Outside Looking In)
Some field assembly is required - Lock/knob NOT included.

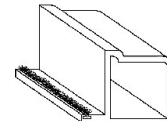

Outside Surround Frame
See Detail on Next Page

SPECIALS:

All Viewguard™ Doors are built to order and as such are considered Custom. Custom orders cannot be cancelled or returned.
Maximum outside surround size 48" X 98" (opening 44" X 96") on Viewguard™ Security Door.
All Viewguard™ Doors come with Surround Frame installed on Top & Sides (see Detail Next Page).
For a '4 Sided Surround' (bottom included) add \$35 List up to 48" x 98" and \$60 List up to 96" x 98".
Custom paint colors are available, call factory for pricing.

HARDWARE:

Hardware shall be aluminum, stainless steel, or other non-corrosive material compatible with aluminum.
Locking Hardware and closer are not included with this door.

OPTIONS:

Heavy-duty pneumatic door closer, with a 1-1/2" diameter tube, is available.
Doors are prepped for a 2-1/8" lock set hole size, to accept a standard handle and lock set (**sold separately**).
We offer a variety of door handles and dead bolts. See next page for additional door components.

PACKAGING:

Viewguard™ Security Doors are packaged individually with top, side & bottom cardboard trays.
See [Packaging Chart](#) located in "Shipping Terms and Conditions" to calculate Packaging Fees for orders shipping Common Carrier.

Visit Truframesecurityproducts.com
for Customer installed photos featuring
our entire line of Security Products.



SCREENING:

High Tensil Security Mesh. 316 Series Stainless Steel Marine Grade, .032 wire diameter woven in a 12 x 12 mesh & powder coated for additional corrosion protection.



TRU-FRAME®
A name you can build on.

PART NO. DESCRIPTION FINISH LIST PRICE

DOOR CLOSERS



C6600BL	Heavy Duty Pneumatic Door Closer	Black	\$43.50
C6600WH	Heavy Duty Pneumatic Door Closer	White	\$43.50

STANDARD KNOBS/DEADBOLTS



C6300PB	Kwikset Security - Polo	Polished Brass	\$69.50
C6300SN	Kwikset Security - Polo	Satin Nickel	\$81.00
C6400PB	Kwikset Security Grade 3 Deadbolt	Polished Brass	\$70.50
C6400SN	Kwikset Security Grade 3 Deadbolt	Satin Nickel	\$77.00

HEAVY DUTY KNOBS/DEADBOLTS



** Indicates
'Smart Key' Enabled

C6350PB **	Kwikset Maximum Security - Cameron	Polished Brass	\$112.00
C6350SN **	Kwikset Maximum Security - Cameron	Satin Nickel	\$119.00
C6450PB **	Kwikset Max Security Grade 2 Deadbolt	Polished Brass	\$112.00
C6450SN **	Kwikset Max Security Grade 2 Deadbolt	Satin Nickel	\$132.50

Viewguard™ Surround Detail

The Viewguard™ is a surface mount door. 3-Sided Surround is standard. A 4-Sided Surround is available (extra charge). Please use illustrations below to help determine exact size required.

Order forms for the Viewguard™ are located at the back of Section-C or can be found along with additional drawings, brochures and installation instructions for any of our products at:
www.Triframe.com/catalog

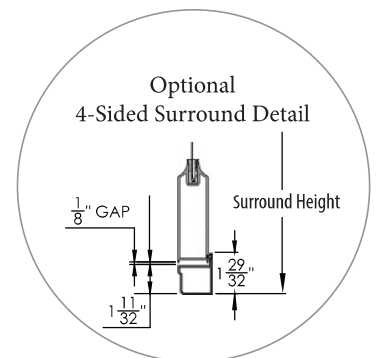
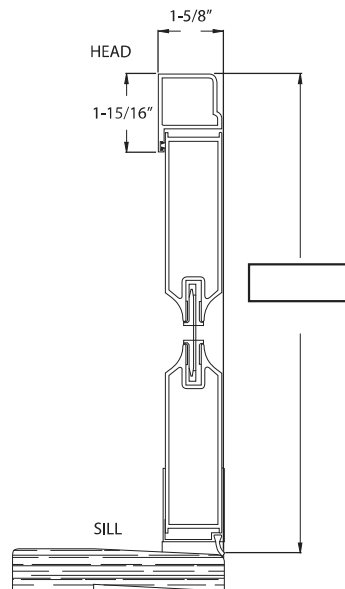
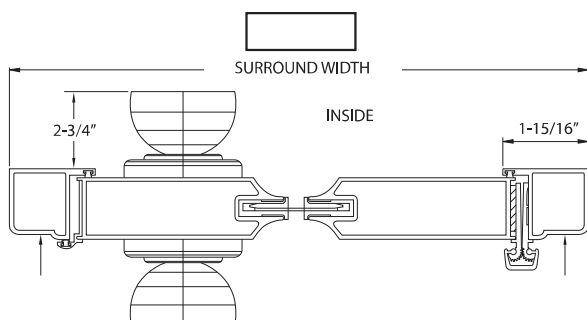



TRU-FRAME®
A name you can build on.

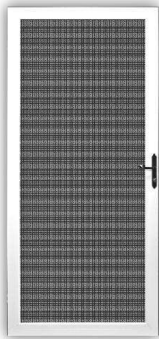

TruView - C654 - Pre-Hung

Bronze Anodized	-	\$1,459.00
White Paint	-	\$1,391.50

Pre-Hung Z-Bar Style TruView Security Door
3" x 1" x .062" Extruded Aluminum
316 Series Stainless Steel Mesh - 12 x 12 x .032
Stainless Steel Hinges (3)
Specify hinge side, LH or RH

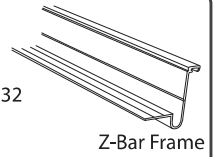

TruView - C654H - Hinge Expander

Bronze Anodized	-	\$1432.00
White Paint	-	\$1355.50

Hinge Expander Style Security Door
316 Series Stainless Steel Mesh - 12 x 12 x .032
3" x 1" x .062" Extruded Aluminum
Stainless Steel Hinges (3)

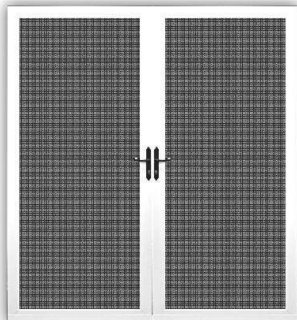
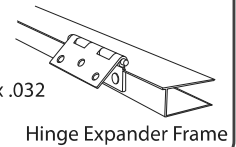

TruView FRENCH - C674

Bronze Anodized	-	\$2,908.00
White Paint	-	\$2,777.00

Hinge Expander TruView Security Door French Set
3" x 1" x .062" Extruded Aluminum
316 Series Stainless Steel - 12 x 12 x .032
Security Doors with Astragal Kit
Stainless Steel Hinges (3)

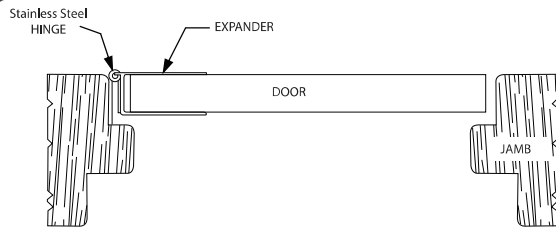
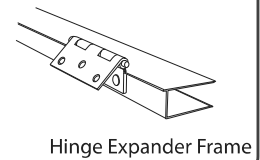

HINGE EXPANDER STYLE

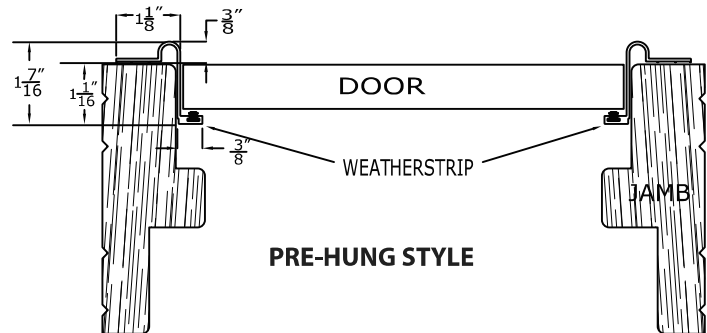

PRE-HUNG STYLE

SPECIALS:

Up to 37" width or 81" height, add \$60.00 per door to list price (\$120 for pairs).
Over 37" width or 81" height, add \$110 per door to list price (\$220 for pairs).
Maximum opening size on TruView Security doors 48" x 96".
Charge to relocate hardware \$25.00 per door added to list price.
Special Colors are Available - Contact Customer Service for Quote.
Custom orders cannot be cancelled or returned.

SCREENING:

High Tensil Security Mesh. 316 Series Stainless Steel Marine Grade, .032 wire diameter woven in a 12 x 12 mesh & powder coated for additional corrosion protection.

HARDWARE:

Hardware includes security lock with keyed deadbolt, thumb-turn cylinder, pneumatic closer, wind safety chain and installation screws.

PACKAGING:

Security doors are packaged with top and bottom cardboard trays. See [Packaging Chart](#) located in "Shipping Terms and Conditions" to calculate Packaging Fees for orders shipping Common Carrier.

Opening Sizes for Standard Size Tru-View Doors

Stock Size	Hinge Expander Style		Pre Hung Style	
	Fits Opening Width	Fits Opening Width	Fits Opening Width	Fits Opening Width
30" x 80"	29-7/8" to 30-5/8"	29-7/8" to 30-1/4"		
32" x 80"	31-7/8" to 32-5/8"	31-7/8" to 32-1/4"		
36" x 80"	35-7/8" to 36-5/8"	35-7/8" to 36-1/4"		

NOTE: All fit an Opening Height of 79-3/4" to 81-1/4".
See Page 16 For Details on Installation and Hardware





TRU-FRAME® A name you can build on.

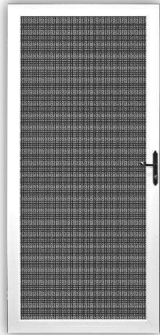

TRU-VIEW™ SURFACE - C664

PART NO.	Max Surround Size Max Opening Size	36" x 82" 32" x 80"	36" x 98" 32" x 96"	42" x 82" 38" x 80"	42" x 98" 38" x 96"	48" x 82" 44" x 80"	48" x 98" 44" x 96"
C664BA	Bronze Anodized	\$1,644.50	\$1,858.50	\$1,672.00	\$1,889.00	\$2,070.00	\$2,153.00
C664WH	White Paint	\$1,544.50	\$1,746.00	\$1,567.50	\$1,770.50	\$1,947.00	\$2,025.00

Heavy-Duty Security Door (Surface Mount Only)
 Specify hinge side, LH or RH
 3" x 1" x .062" Extruded Aluminum Door Frame
 1-7/8" x 1-9/16" x .093 Extruded Aluminum 3-Sided Surround
 316 Series Stainless Steel Mesh - 12 x 12 x .032
 Stainless Steel Hinges (3)

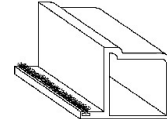

Outside Surround Frame

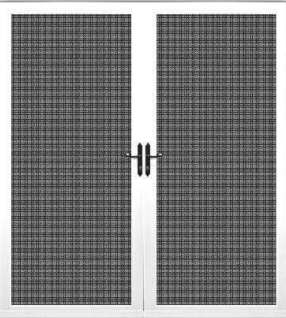

TRU-VIEW™ SURFACE FRENCH DOOR - C668

PART NO.	Max Surround Size Max Opening Size	72" x 82" 68" x 80"	72" x 98" 68" x 96"	84" x 82" 80" x 80"	84" x 98" 80" x 96"	96" x 82" 92" x 80"	96" x 98" 92" x 96"
C668BA	Bronze Anodized	\$3,341.00	\$3,775.50	\$4,187.00	\$4,384.50	\$4,388.50	\$4,467.00
C668WH	White Paint	\$3,135.00	\$3,543.00	\$3,941.50	\$4,121.00	\$4,118.50	\$4,192.50

Heavy-Duty French Security Door (Surface Mount Only)
 Includes 2 Tru-View™ Surface Security Doors (Above) and complete 3-Sided Surround Frame & Astragal for French Door Application.
 Specify OX or XO (Outside Looking In. **Some field assembly is required.**)

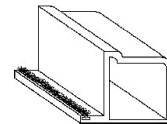

Outside Surround Frame

SPECIALS:

All Tru-View™ Surface Security Doors are built to order and as such are considered Custom.
Custom orders cannot be cancelled or returned.

Maximum outside surround size 48" X 98" (opening 44" X 96") on Tru-View™ Surface™ Security Door.
 All Tru-View™ Surface Security Doors come with Surround Frame installed on Top & Sides.
 For a 4-Sided Surround (bottom included) add \$35 List up to 48" x 98" and \$60 List up to 96" x 98".

Custom paint colors are available, call factory for pricing.

HARDWARE:

Hardware includes a Deluxe Security Lock with Keyed-Deadbolt, Thumb-Turn Cylinder and Installation screws.

OPTIONS:

Heavy-Duty Pneumatic Door Closer, with a 1-1/2" diameter tube, is available as an option.

PACKAGING:

Tru-View™ Surface Security Doors are packaged individually with top, side & bottom cardboard trays.
 See [Packaging Chart](#) located in "Shipping Terms and Conditions" to calculate Packaging Fees for orders shipping Common Carrier



SCREENING:

High Tensil Security Mesh. 316 Series Stainless Steel Marine Grade, .032 wire diameter woven in a 12 x 12 mesh & powder coated for additional corrosion protection.

Visit Truframesecurityproducts.com for Customer installed photos featuring our entire line of Security Products.



TRU-FRAME®
A name you can build on.



TRU-FRAME® - C514

Bronze Anodized		-	\$821.00
White Paint		-	\$741.00

Pre-Hung Z-Bar Style Security Door

3" x 1" x .062" Extruded Aluminum
Amplimesh Grille with Charcoal Aluminum Wire
Specify hinge side, LH or RH
Stainless Steel Hinges (3)

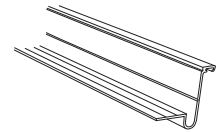

Z-Bar Frame

TRU-FRAME® - C514H

Bronze Anodized		-	\$795.00
White Paint		-	\$714.50

Hinge Expander Style Security Door

3" x 1" x .062" Extruded Aluminum
Amplimesh Grille with Charcoal Aluminum Wire
Stainless Steel Hinges (3)

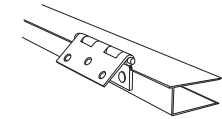

Hinge Expander Style



TRU-FRAME® FRENCH - C534

Bronze Anodized		-	\$1,583.00
White Paint		-	\$1,450.50

Hinge Expander Style French Doors

3" x 1" x .062" Extruded Aluminum
Amplimesh Grille with Charcoal Aluminum Wire
Security Doors with Astragal Kit
Stainless Steel Hinges (3)

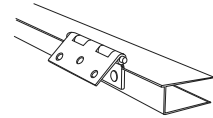

Hinge Expander Style Frame

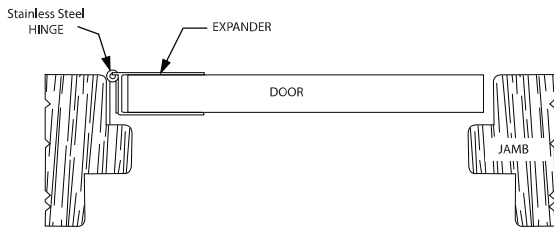

HINGE EXPANDER STYLE

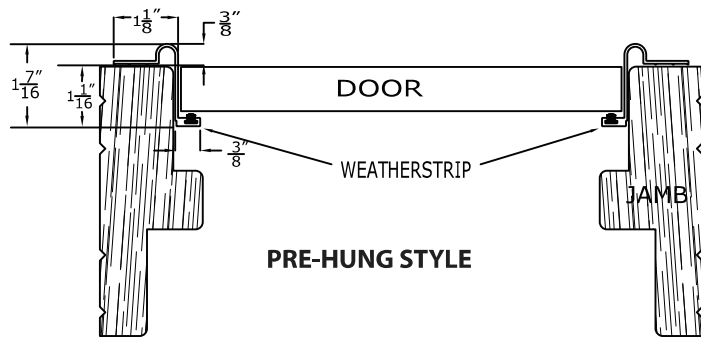

PRE-HUNG STYLE

STANDARD SIZES:

36" x 80" - 32" x 80" - 30" x 80"

SPECIALS:

Up to 42" width or 84" height, add \$65.00 per door list price (\$120 for pairs)
Over 42" width or 84" height, add \$110.00 per door to list price (\$220 for pairs)
Maximum opening size on Tru-Frame® Security doors 48" x 96".
Charge to relocate hardware, add \$25.00 per door to list price.
Special Colors are Available - Contact Customer Service for Quote
Custom orders cannot be cancelled or returned.

Opening Sizes for Standard Size Tru-Frame® Doors

Stock Size	Hinge Expander Style		Pre Hung Style	
	Fits Opening Width	Fits Opening Width	Fits Opening Width	Fits Opening Width
30" x 80"	29-7/8" to 30-5/8"	29-7/8" to 30-1/4"		
32" x 80"	31-7/8" to 32-5/8"	31-7/8" to 32-1/4"		
36" x 80"	35-7/8" to 36-5/8"	35-7/8" to 36-1/4"		

NOTE: All fit an Opening Height of 79-3/4" to 81-1/4".
See Page 16 For Details on Installation and Hardware

SCREENING:

Charcoal aluminum screening. (Additional screen materials available as special order).

HARDWARE:

Hardware includes deluxe security lock with keyed deadbolt, thumb-turn cylinder, pneumatic closer, wind safety chain and installation screws.

PACKAGING:

Security doors are packaged with top and bottom cardboard trays.
See [Packaging Chart](#) located in "Shipping Terms and Conditions" to calculate Packaging Fees for orders shipping Common Carrier.



TRU-FRAME® A name you can build on.



TRU-FRAME® SURFACE - C564

PART NO.	Max Surround Size Max Opening Size	36" x 82" 32" x 80"	36" x 98" 32" x 96"	42" x 82" 38" x 80"	42" x 98" 38" x 96"	48" x 82" 44" x 80"	48" x 98" 44" x 96"
C564BA	Bronze Anodized	\$1016.00	\$1205.00	\$1126.00	\$1,247.00	\$1,200.50	\$1,292.50
C564WH	White Paint	\$898.00	\$1076.50	\$1001.50	\$1114.00	\$1073.00	\$1,207.50

Heavy-Duty Security Door (Surface Mount Only)
Specify hinge side, LH or RH
3" x 1" x .062" Extruded Aluminum Door Frame
1-7/8" x 1-9/16" x .093 Extruded Aluminum 3-Sided Surround
Amplimesh Grille with Charcoal Aluminum Wire
Stainless Steel Hinges (3)

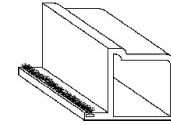

Outside Surround Frame



TRU-FRAME® SURFACE FRENCH DOOR - C568

PART NO.	Max Surround Size Max Opening Size	72" x 82" 68" x 80"	72" x 98" 68" x 96"	84" x 82" 80" x 80"	84" x 98" 80" x 96"	96" x 82" 92" x 80"	96" x 98" 92" x 96"
C568BA	Bronze Anodized	\$1,985.00	\$2,355.00	\$2,213.00	\$2,370.50	\$2,284.50	\$2,403.00
C568WH	White Paint	\$1,744.50	\$2,101.00	\$1,961.00	\$2,116.00	\$2,027.50	\$2,153.00

Heavy-Duty French Security Door (Surface Mount Only)
Includes Tru-Frame® Surface Security Doors (Above) and complete 3-Sided Surround Frame & Astragal for French Door Application.
Specify OX or XO (Outside Looking In).
Some field assembly is required.

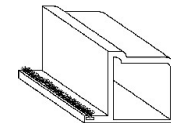

Outside Surround Frame

SPECIALS:

All Tru-Frame® Surface Security Doors are built to order and as such are considered Custom.
Custom orders cannot be cancelled or returned.

Maximum outside surround size 48" X 98" (opening 44" X 96") on Tru-Frame® Surface™ Security Door.
All Tru-Frame® Surface Security Doors come with Surround Frame installed on Top & Sides.
For a 4-Sided Surround' (bottom included) add \$35 List up to 48" x 98" and \$60 List up to 96" x 98".

Custom paint colors are available, call factory for pricing.

SCREENING:

Amplimesh Grille with Charcoal Aluminum Wire. (Additional screen materials available as special order).

HARDWARE:

Hardware includes a Deluxe Security Lock with Keyed-Deadbolt, Thumb-Turn Cylinder and Installation Screws.

OPTIONS:

Heavy-Duty Pneumatic Door Closer, with a 1-1/2" diameter tube, is available as an option.

PACKAGING:

Tru-Frame® Surface Security Doors are packaged individually with top, side & bottom cardboard trays.
See [Packaging Chart](#) located in "Shipping Terms and Conditions" to calculate Packaging Fees for orders shipping Common Carrier.

Visit Truframesecurityproducts.com
for Customer installed photos featuring
our entire line of Security Products.



TRU-FRAME®
A name you can build on.

Stainless Steel Security Mesh System

ITEM NUMBER	NOMINAL SIZE	OUTSIDE FRAME DIMENSION UP TO	FINISHED OPENING UP TO	DOUBLE / SINGLE DOOR	COLOR	LIST PRICE
C774BA6080OX or XO	5'0" x 6'8"	64" x 84"	60" x 80"	Double Door / Stainless	Bronze Anod	\$3,803.50
C774BA7280OX or XO	6'0" x 6'8"	76" x 84"	72" x 80"	Double Door / Stainless	Bronze Anod	\$3,881.50
C774BA7296OX or XO	6'0" x 8'0"	76" x 100"	72" x 96"	Double Door / Stainless	Bronze Anod	\$4,346.00
C774BA9680OX or XO	8'0" x 6'8"	100" x 84"	96" x 80"	Double Door / Stainless	Bronze Anod	\$5,026.50
C774BA9696OX or XO	8'0" x 8'0"	100" x 100"	96" x 96"	Double Door / Stainless	Bronze Anod	\$5,160.50
C774WH6080OX or XO	5'0" x 6'8"	64" x 84"	60" x 80"	Double Door / Stainless	White Paint	\$3,500.00
C774WH7280OX or XO	6'0" x 6'8"	76" x 84"	72" x 80"	Double Door / Stainless	White Paint	\$3,565.50
C774WH7296OX or XO	6'0" x 8'0"	76" x 100"	72" x 96"	Double Door / Stainless	White Paint	\$3,991.50
C774WH9680OX or XO	8'0" x 6'8"	100" x 84"	96" x 80"	Double Door / Stainless	White Paint	\$4,647.50
C774WH9696OX or XO	8'0" x 8'0"	100" x 100"	96" x 96"	Double Door / Stainless	White Paint	\$4,756.00
C754BA6080OX or XO	5'0" x 6'8"	64" x 84"	60" x 80"	Single Door / Stainless	Bronze Anod	\$2,406.00
C754BA7280OX or XO	6'0" x 6'8"	76" x 84"	72" x 80"	Single Door / Stainless	Bronze Anod	\$2,451.00
C754BA7296OX or XO	6'0" x 8'0"	76" x 100"	72" x 96"	Single Door / Stainless	Bronze Anod	\$2,698.00
C754BA9680OX or XO	8'0" x 6'8"	100" x 84"	96" x 80"	Single Door / Stainless	Bronze Anod	\$3,028.00
C754BA9696OX or XO	8'0" x 8'0"	100" x 100"	96" x 96"	Single Door / Stainless	Bronze Anod	\$3,111.50
C754WH6080OX or XO	5'0" x 6'8"	64" x 84"	60" x 80"	Single Door / Stainless	White Paint	\$2,190.00
C754WH7280OX or XO	6'0" x 6'8"	76" x 84"	72" x 80"	Single Door / Stainless	White Paint	\$2,227.00
C754WH7296OX or XO	6'0" x 8'0"	76" x 100"	72" x 96"	Single Door / Stainless	White Paint	\$2,448.00
C754WH9680OX or XO	8'0" x 6'8"	100" x 84"	96" x 80"	Single Door / Stainless	White Paint	\$2,765.50
C754WH9696OX or XO	8'0" x 8'0"	100" x 100"	96" x 96"	Single Door / Stainless	White Paint	\$2,832.00

Special Size Only:

NOTE: SLIDING SECURITY SCREEN DOORS CANNOT BE CANCELLED OR RETURNED. ALL SLIDING SECURITY SCREEN DOORS ARE BUILT TO ORDER SPECIFICATIONS. Verify all dimensions before submitting order - Signed Confirmations will be REQUIRED before factory begins processing any orders for Sliding Security Screen Doors.

Frame Colors / Options:

Bronze Anodized and White Paint are standard. Special colors are available
BA = Bronze Anodized WH = White Paint SP = Special

Hardware:

Standard locking system is a Secure 2-Point Inside Lever Lock with Black Pull Handles.

Heavy-duty adjustable wheel system (4 each per door) w/all Stainless Components.
The stationary panel contains no hardware. Non-operating handle can be added for \$60.00 list.

Packaging:

All Assembled Sliders come encased in 2x4 crate - eases transportation to job site. KD Kits available; Door panels are complete - track system is pre-drilled for quick assembly.

Samples:

Free standing 48" x 46" Door Display with 2-Point locking system is available
Double Door Sample (WH): \$1029 List Price. Single Door Sample (WH): \$792 List Price.

Screening:

High Tensil Security Mesh. 316 Series Stainless Steel Marine Grade, .032 wire diameter woven in a 12 x 12 mesh & powder coated for additional corrosion protection.

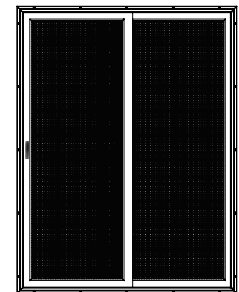

Double Door

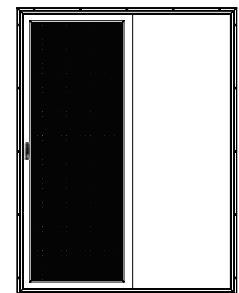

Single Door





TRU-FRAME®
A name you can build on.

Amplimesh Screen System

ITEM NUMBER	NOMINAL SIZE	OUTSIDE FRAME DIMENSION UP TO	FINISHED OPENING UP TO	DOUBLE / SINGLE DOOR	COLOR	LIST PRICE
C734BA6080OX or XO	5'0" x 6'8"	64" x 84"	60" x 80"	Double Door / Amplimesh	Bronze Anod	\$2,518.50
C734BA7280OX or XO	6'0" x 6'8"	76" x 84"	72" x 80"	Double Door / Amplimesh	Bronze Anod	\$2,592.00
C734BA7296OX or XO	6'0" x 8'0"	76" x 100"	72" x 96"	Double Door / Amplimesh	Bronze Anod	\$2,709.00
C734BA9680OX or XO	8'0" x 6'8"	100" x 84"	96" x 80"	Double Door / Amplimesh	Bronze Anod	\$2,737.00
C734BA9696OX or XO	8'0" x 8'0"	100" x 100"	96" x 96"	Double Door / Amplimesh	Bronze Anod	\$2,853.50
C734WH6080OX or XO	5'0" x 6'8"	64" x 84"	60" x 80"	Double Door / Amplimesh	White Paint	\$2,254.00
C734WH7280OX or XO	6'0" x 6'8"	76" x 84"	72" x 80"	Double Door / Amplimesh	White Paint	\$2,311.00
C734WH7296OX or XO	6'0" x 8'0"	76" x 100"	72" x 96"	Double Door / Amplimesh	White Paint	\$2,402.50
C734WH9680OX or XO	8'0" x 6'8"	100" x 84"	96" x 80"	Double Door / Amplimesh	White Paint	\$2,427.50
C734WH9696OX or XO	8'0" x 8'0"	100" x 100"	96" x 96"	Double Door / Amplimesh	White Paint	\$2,518.50
C714BA6080OX or XO	5'0" x 6'8"	64" x 84"	60" x 80"	Single Door / Amplimesh	Bronze Anod	\$1,823.50
C714BA7280OX or XO	6'0" x 6'8"	76" x 84"	72" x 80"	Single Door / Amplimesh	Bronze Anod	\$1,866.50
C714BA7296OX or XO	6'0" x 8'0"	76" x 100"	72" x 96"	Single Door / Amplimesh	Bronze Anod	\$1,943.00
C714BA9680OX or XO	8'0" x 6'8"	100" x 84"	96" x 80"	Single Door / Amplimesh	Bronze Anod	\$1,954.50
C714BA9696OX or XO	8'0" x 8'0"	100" x 100"	96" x 96"	Single Door / Amplimesh	Bronze Anod	\$2,032.00
C714WH6080OX or XO	5'0" x 6'8"	64" x 84"	60" x 80"	Single Door / Amplimesh	White Paint	\$1,629.00
C714WH7280OX or XO	6'0" x 6'8"	76" x 84"	72" x 80"	Single Door / Amplimesh	White Paint	\$1,664.00
C714WH7296OX or XO	6'0" x 8'0"	76" x 100"	72" x 96"	Single Door / Amplimesh	White Paint	\$1,722.50
C714WH9680OX or XO	8'0" x 6'8"	100" x 84"	96" x 80"	Single Door / Amplimesh	White Paint	\$1,734.00
C714WH9696OX or XO	8'0" x 8'0"	100" x 100"	96" x 96"	Single Door / Amplimesh	White Paint	\$1,793.50

Special Size Only:

NOTE: SLIDING SECURITY SCREEN DOORS CANNOT BE CANCELLED OR RETURNED.
ALL SLIDING SECURITY SCREEN DOORS ARE BUILT TO ORDER SPECIFICATIONS.
Verify all dimensions before submitting order - Signed Confirmations will be REQUIRED before factory begins processing any orders for Sliding Security Screen Doors

Frame Colors / Options:

Bronze Anodized and White Paint are standard. Special colors are available
BA = Bronze Anodized WH = White Paint SP = Special

Amplimesh Screen:

Amplimesh Grille with Charcoal Aluminum Wire. (Additional screen materials available as special order).

Hardware:

Standard locking system is a Secure 2-Point Inside Lever Lock with Black Pull Handles.
Heavy-duty adjustable wheel system (4 each per door) w/all Stainless Components
The stationary panel contains no hardware. Non-operating handle can be added for \$60.00 list.

Packaging:

All Assembled Sliders come encased in 2x4 crate - eases transportation to job site. KD Kits available;
Door panels are complete - track system is pre-drilled for quick assembly.

Samples:

Free standing 48" x 46" Door Display with 3-Point locking system is available
Double Door Sample (WH): \$950.50 List Price
Single Door Sample (WH): \$550.00 List Price

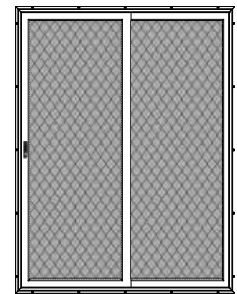

Double Door

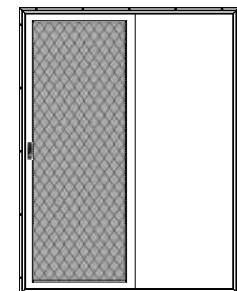

Single Door

SECTION C



TRU-FRAME®
A name you can build on.

Security Slider Configurations

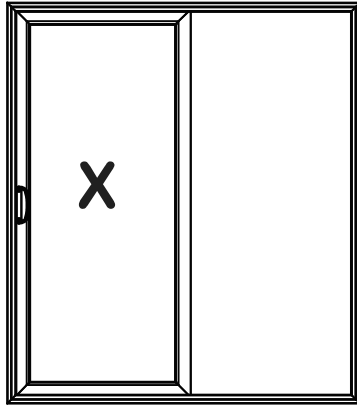

C754 - Single Slider

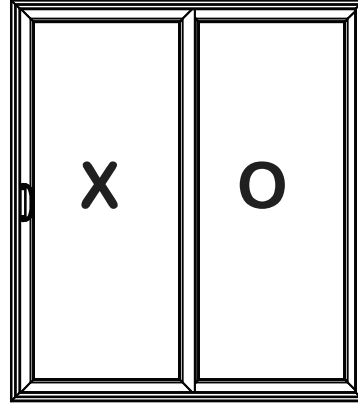

C774 - Double Slider

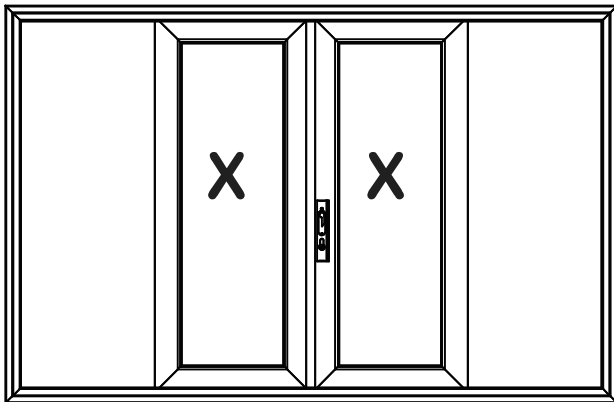

C775 - XX
2-Panel Slider

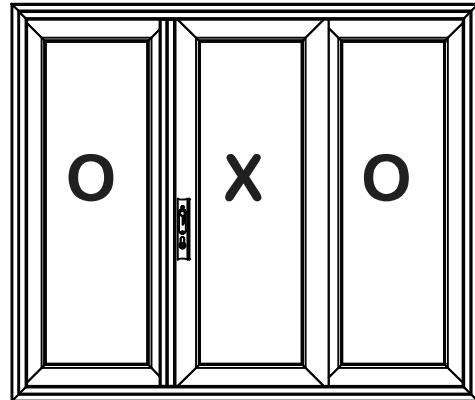

C776 - OXO
3-Panel Slider

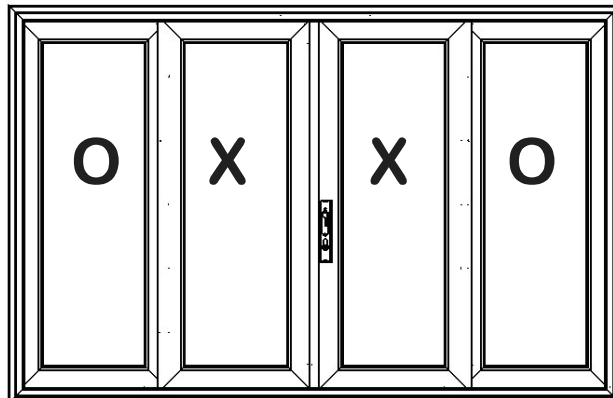

C777 - OXOX
4-Panel Slider

*Illustrations Shown are
XO
(Active Door Slides Right)*



TRU-FRAME®
A name you can build on.

CE7090 Frame Extension for Security Slider (Optional)

Double Security Slider
Frame with Extension
(Outside View)

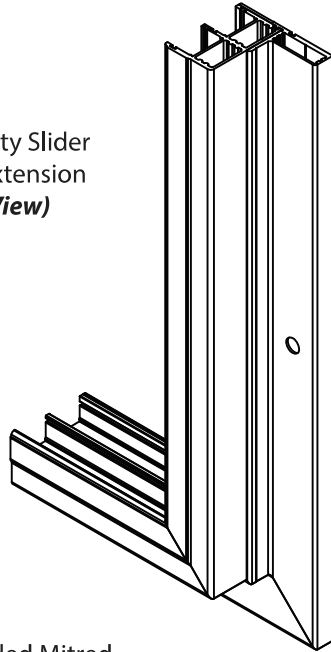

4-Sided Mitred
Extension Shown

Single Security Slider
Frame with Extension
(Outside View)

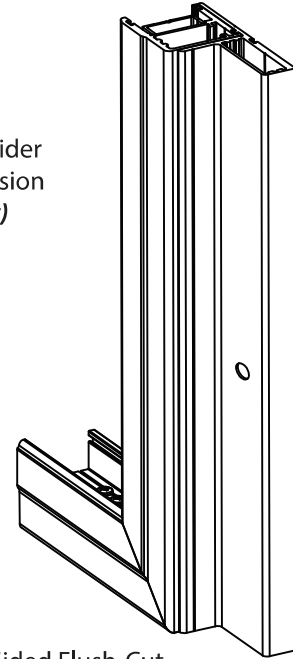

3-Sided Flush-Cut
Extension Shown

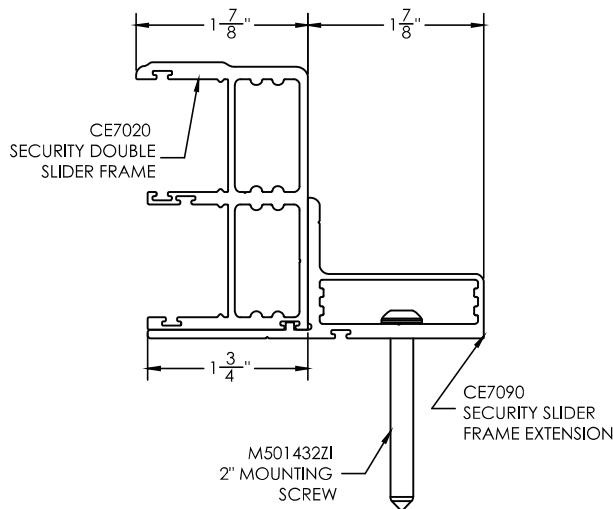

Extension with Double
Security Slider Frame

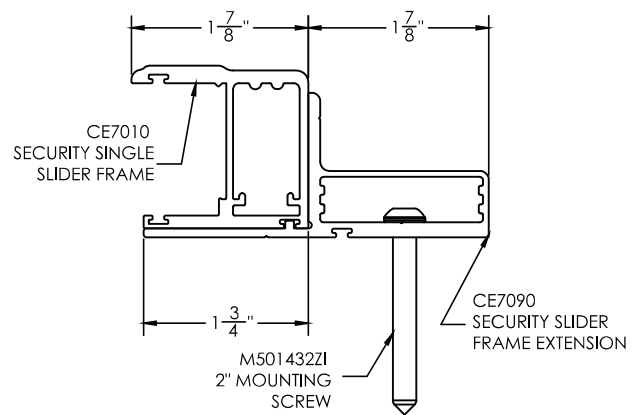





Extension with Single
Security Slider Frame



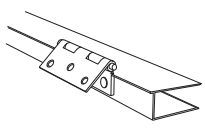

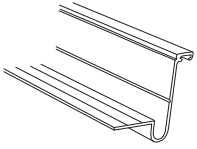

TRU-FRAME®
A name you can build on.

SECTION C

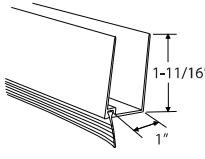
	1" HINGE EXPANDER WITH (3) S.S. HINGES			 BA WH
	B35041WH	Length 80-1/2"	\$72.50	
	B35042WH	Length 96"	\$87.50	
	B35041BA	Length 80-1/2"	\$79.00	
	B35042BA	Length 96"	\$93.50	

	Z-BAR WITH (3) S.S. HINGES			 BR WH BA
	B35071WH, BR	Up To 42" x 84"	\$96.00	
	B35073WH, BR	Over 42" x 84"	\$105.00	
	B35071BA	Up To 42" x 84"	\$107.50	
	B35073BA	Over 42" x 84"	\$114.00	

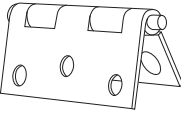
	BOTTOM EXPANDER with VINYL SWEEP			 BA WH
	B35051WH	36-1/2"	\$23.50	
	B35052WH	35-3/8"	\$21.00	
	B35051BA	36-1/2"	\$27.50	
	B35052BA	35-3/8"	\$23.50	

	SECURITY DOOR HINGES - STAINLESS STEEL			 BL WH
	B1171WHSS, BLSS	Pre-Hung Style Doors	\$10.50	
	C3242WHSS, BLSS	HHinge Expander Style Doors	\$15.00	

FRENCH DOOR KITS	FRENCH DOOR KITS			French Security Door Kit 84" French Security Door Kit 96"
	C15071BA, WH	-	\$72.50	
	C15072BA, WH	-	\$76.50	

CLOSERS	PNEUMATIC CLOSERS			Wright Pneumatic Closer Kit with Wind Chain
	C5390BL, WH	-	\$47.00	

	FLOOR DISPLAYS AND HAND SAMPLES			Tru-Frame® Security Door (WH) w/ Display Stand and Sign Viewguard™ Security Door (WH) w/ Display Stand and Sign Tru-View™ Security Door (WH) w/ Display Stand and Sign Security Slider Display (WH) w/ Display Stand (48" x 48") Tru-Frame®/TruView™ Stand/Sign Only (Door Not Included) Viewguard™ Display Stand & Sign Only (Door Not Included) Tru-Frame® Security Door Display - Sign Only Viewguard™ Security Door Display - Sign Only Tru-View™ Security Door Display - Sign Only Tru-Frame® Sample Security Door - White 16" x 32" Tru-View™ Sample Security Door - White 16" x 32"
	C514BASMPL-DISPLAY		\$1,973.00	
	C614WHSMPL-DISPLAY		\$2,150.50	
	C654WHSMPL-DISPLAY		\$1,700.00	
	C774WHSMPL48		\$950.50	
	CDS100BL	-	\$660.00	
	CDS600BL	-	\$1,815.00	
	CDS101	-	\$70.00	
	CDS102	-	\$70.00	
	CDS103	-	\$70.00	
	C514WHSMPL	-	\$275.00	
C654WHSMPL	-	\$396.00		



TRU-FRAME®
A name you can build on.

Locksets

Cylinders

Misc. Hardware

Security Locksets		
C5372BL	Replacement Only	\$143.50
C5373BL	Vermont Handle	\$103.00
C5374BL *	Contour Handle	\$115.00
C5376BL	Tasman Handle	\$194.50
Lock Cylinders		
C5380	T-Turn Teardrop	\$24.00
C5380K	T-Turn Teardrop	\$24.00
C5380S	T-Turn Teardrop	\$24.00
C5381	T-Turn Rectangle	\$32.00
C5381K	T-Turn Rectangle	\$32.00
C5382	Double Key, Rectangle	\$35.00
C5382K	Double Key, Rectangle	\$32.00
C7378-CYL	T-Turn Teardrop	\$93.00
C7378K-CYL	T-Turn Teardrop	\$93.00
C7378D-CYL	Double Key, Teardrop	\$93.00
C5403	Key Blanks	\$7.50
Misc. Security Hardware		
C5375##	Tru-Frame® Lock Guard	\$13.00
C6700	Security Torx Bit	\$9.00
C7075##	96" Bugseal	\$10.00
C7076##	3.5" X 98" Bugseal	\$20.00
C7390BL	2-Pt Handle Assembly	\$80.00
C7391BL	Security Slider Pull Handle	\$40.00
C7150SS	Security Slider Roller	\$16.00
C6230##	1/2" Hole Plug	\$1.50
C7230##	3/8" Hole Plug	\$1.00
CE7090BA	Sec Slider Extension - Per/Ft	\$15.00
CE7090WH	Sec Slider Extension - Per/Ft	\$13.00

Primeline Replacement Mortice Lock
Wright Vermont T-Turn, Rectangle Cylinder
Wright Contour T-Turn, Teardrop (Kwikset)
Whitco MK3 T-Turn, Teardrop Cylinder

Wright Euro Cylinder (Kwikset Re-Keyable)
Wright Euro Keyed Alike (Kwikset Re-Keyable)
Wright Euro Cylinder (Schlage Re-Keyable)
Wright Junior Cylinder (NOT Re-Keyable)
Wright Junior Cylinder (Keyed Alike)
Wright Junior Cylinder
Wright Junior Cylinder (Keyed Alike)
Whitco Euro Universal Cylinder
Whitco Euro Universal Cylinder (Keyed Alike)
Whitco Double-Key Cylinder
Wright Junior Key Blanks

Polycarbonate Lock Guard with Screws - ## Bkck or White
Viewguard and Surface Mount TruView
96" Vinyl Bugseal W/Adhesive - ## Black, Bronze or White
3.5"X 98" Dual Duro Bugseal - ## Bkck or White
Rockwell 2-Point Pull Handle Assembly - Black
Rockwell Security Slider Pull Handle - Black
Whitco Security Slider Roller #3030
1/2" Hole Plug - ## Bronze or White
3/8" Hole Plug - ## Bronze or White
Security Slider Extension - Bronze Anodize
Security Slider Extension - White Paint

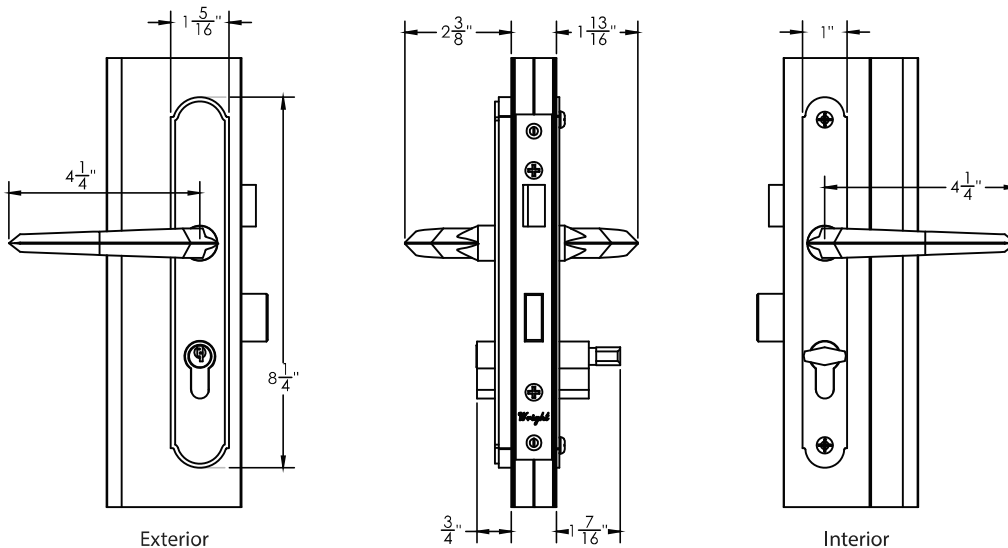

* C5374BL
Tru-Frame® and TruView™
Hardware Dimensions



TRU-FRAME®
A name you can build on.

Special "C" Viewguard™ Door
Fax Number: 888-526-4329

ORDER QUOTE (Check One)

DEALER: _____

DATE: _____

PO#/ JOB NAME: _____

Completed by: _____

DOOR STYLE (circle one): **C614-Single Door** or **C634-French Door**

FINISH _____

QUANTITY _____ OUTSIDE SURROUND DIMENSIONS _____ x _____

_____ **(3)**-SIDED SURROUND (3-Sided Surround is Standard)

_____ **(4)**-SIDED SURROUND *(Option - No bottom Expander)

Outside Looking In - SPECIFY HINGE SIDE:

Single Door	French Door
_____ RIGHT HINGE	_____ OX
_____ LEFT HINGE	_____ XO

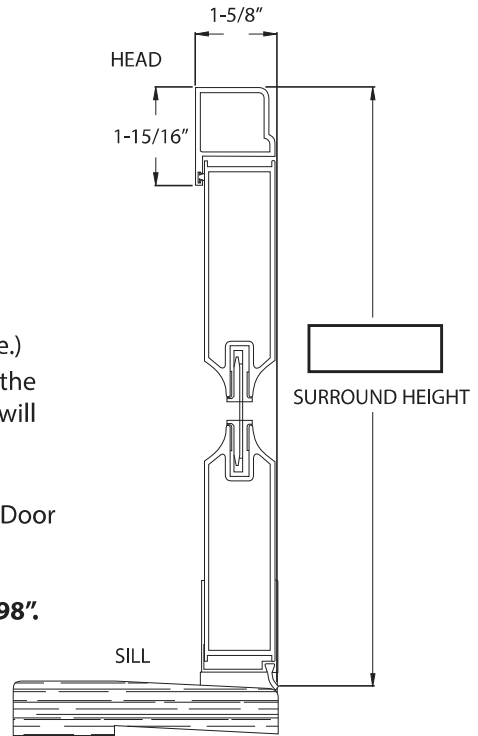

Locate Knob Lock Bore @ _____" to top of Surround. (Deadbolt above.)
The dimensions for a Tru-Frame® Viewguard™ Security Door are derived from the details below (Width) and at right (Height). Measuring by these dimensions will provide a door that will fit your opening.

A standard size door opening that measures 36" x 80" will use a Viewguard™ Door with the "Overall" dimensions of 39-13/16" x 82".

Maximum Overall Size on a Tru-Frame® Viewguard™ Security Door is 48" x 98".

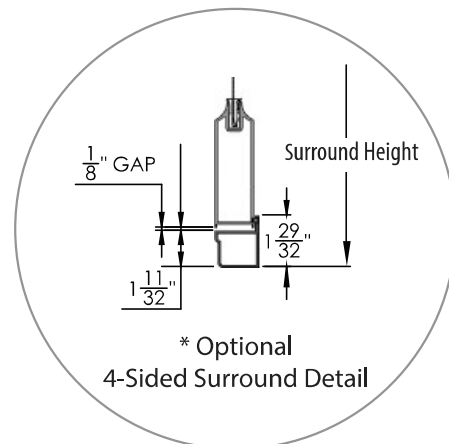
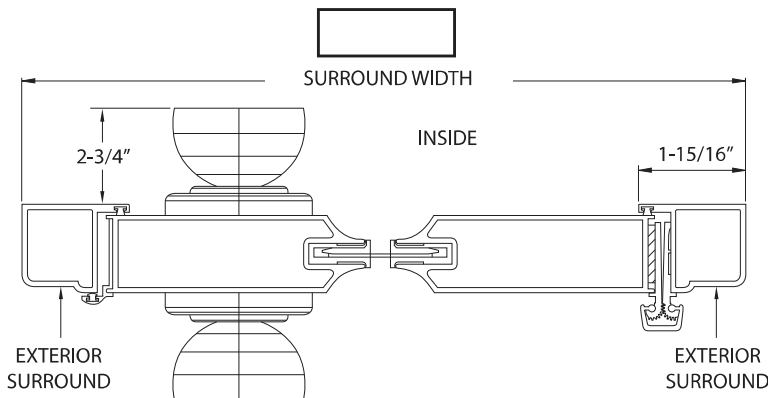

NOTE: Hardware is not included with the purchase of this door.
Please refer to catalog if hardware is needed.

SECTION C



TRU-FRAME®
A name you can build on.

ORDER QUOTE (Check One)

**Special Tru-View™ Security Door
With Stainless Steel Epoxy Coated Mesh**

DEALER: _____

DATE: _____

JOB NAME/PO#: _____

Completed by: _____

DOOR STYLE (circle one): **C654-Single** or **C674-French** **FINISH:** _____

QUANTITY _____ OPENING SIZE _____ x _____

OPTIONS:

____ HINGE EXPANDER (Non-handed unless special lock location specified.)

____ PRE-HUNG ____ RIGHT HINGE ____ XO (French Dr)
(outside looking in) ____ LEFT HINGE ____ OX (French Dr)

Locate Punch @ _____" C/L of Handle to Top of Door.

Special notes: _____

MAXIMUM OPENING SIZE HEIGHT = 96"

	Hinge Expander Style	Pre-Hung Style
SIZE	OPENING WIDTH	OPENING WIDTH
30" x 80"	29-7/8" to 30-5/8"	29-7/8" to 30-1/4"
32" x 80"	31-7/8" to 32-5/8"	31-7/8" to 32-1/4"
36" x 80"	35-7/8" to 36-5/8"	35-7/8" to 36-1/4"

NOTES: Security doors fit an Opening Height of 79-3/4" to 81-1/4".
316 Series Stainless Steel, Epoxy Coated Mesh - 12 x 12 x .032 is standard.
Z-Bar will extend 2" longer at threshold on all pre-hung doors for field fit.

L/H (Left Hinge) style door shown
(Always viewed from exterior)

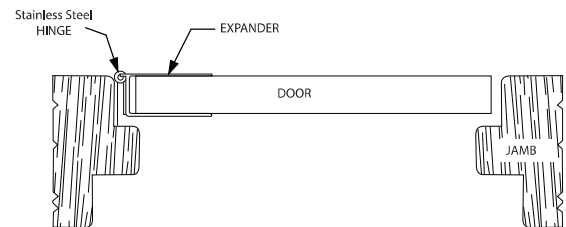
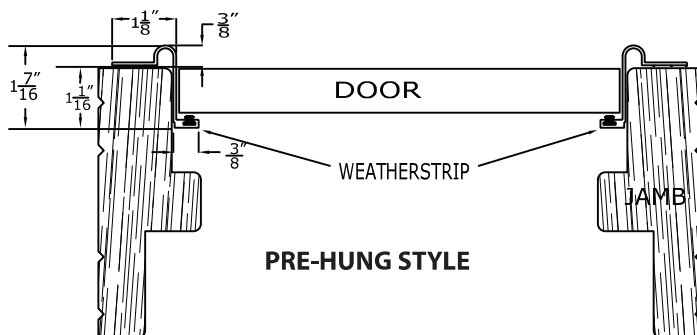
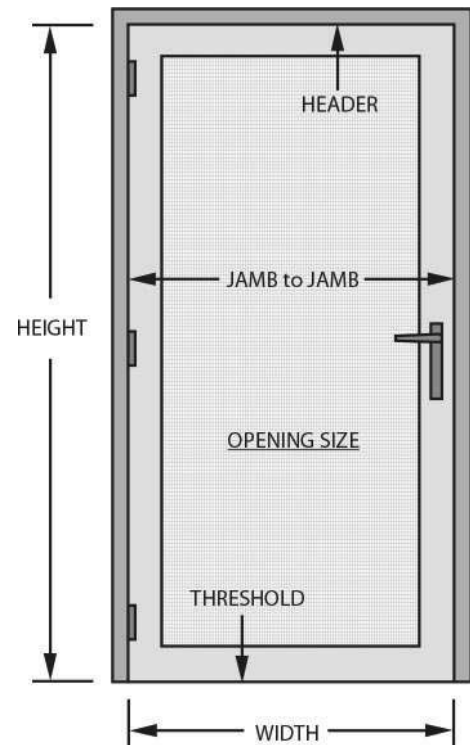

PRE-HUNG STYLE

HINGE EXPANDER STYLE



TRU-FRAME®
A name you can build on.

**Special "C" Tru-View™ Surface Door
With Stainless Steel Epoxy Coated Mesh**

ORDER QUOTE (Check One)

DEALER: _____

DATE: _____

JOB NAME/PO#: _____

Completed by: _____

DOOR STYLE (circle one): **C664-Single** or **C668-French**

FINISH: _____

QUANTITY: _____ **OUTSIDE SURROUND DIMENSIONS: WIDTH:** _____ **X HEIGHT:** _____

OPTIONS:

SINGLE:

FRENCH:

SURFACE MOUNT EXTERIOR PRE-HUNG
(Outside Looking In)

_____ RIGHT HINGE
_____ LEFT HINGE

_____ OX
_____ XO

Locate Punch @ _____" C/L of handle to top of Surround.

Special Notes: _____

The dimensions for a Tru-View™ Surface Security Door are derived from the details below (Width) and at left (Height). Measuring by these dimensions will provide a door that will fit your opening.

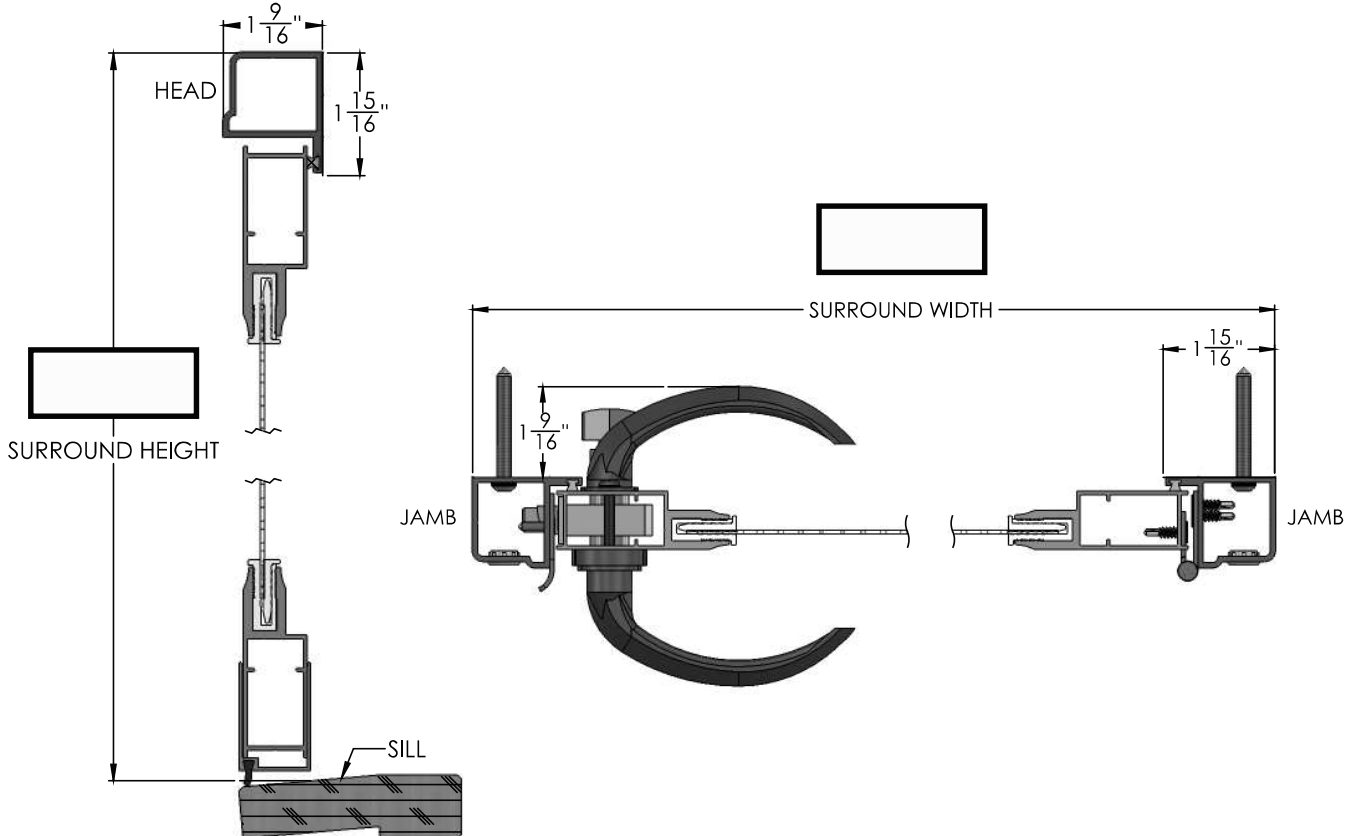

SECTION C



TRU-FRAME® A name you can build on.

ORDER QUOTE (Check One)

Special Tru-Frame® Security Door With Amplimesh Grille & Charcoal Aluminum Wire

DEALER: _____

DATE: _____

JOB NAME/PO#: _____

Completed by: _____

DOOR STYLE (circle one): C514-Single or C534-French FINISH: _____

QUANTITY _____ OPENING SIZE _____ x _____

OPTIONS:

_____ HINGE EXPANDER (Non-handed unless special lock location specified).

_____ PRE-HUNG (outside looking in) _____ RIGHT HINGE _____ LEFT HINGE _____ XO (French Dr) _____ OX (French Dr)

Locate Punch @ _____ C/L of Handle to Top of Door.

Special notes: _____

L/H (Left Hinge) style door shown (Always viewed from exterior)

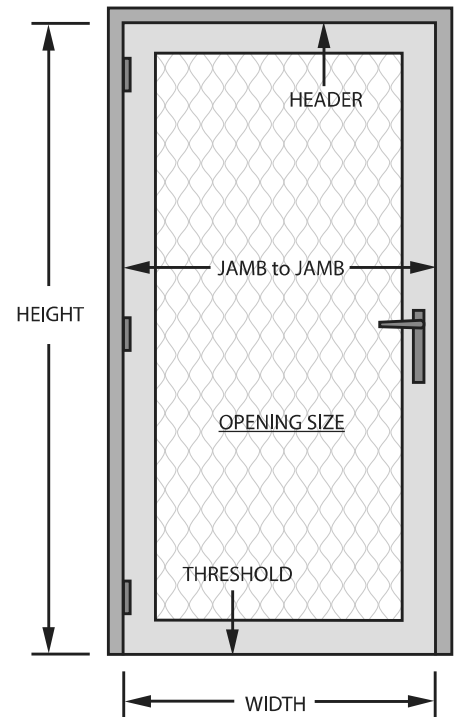

MAXIMUM OPENING SIZE HEIGHT = 96"

SIZE	Hinge Expander Style OPENING WIDTH	Pre-Hung Style OPENING WIDTH
30" x 80"	29-3/4" to 30-7/8"	29-7/8" to 30-1/4"
32" x 80"	31-3/4" to 32-7/8"	31-7/8" to 32-1/4"
36" x 80"	35-3/4" to 36-7/8"	35-7/8" to 36-1/4"

NOTES: Security doors fit an Opening Height of 79-3/4" to 81-1/4". Amplimesh Grille with Charcoal Alum Wire is standard. Z-Bar will extend 2" longer at threshold on all pre-hung doors for field fit.

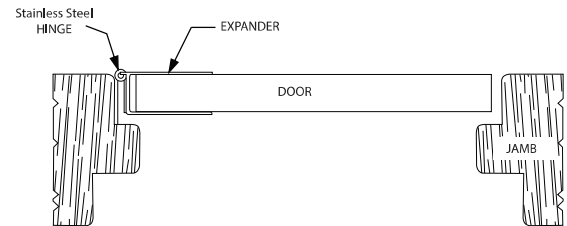
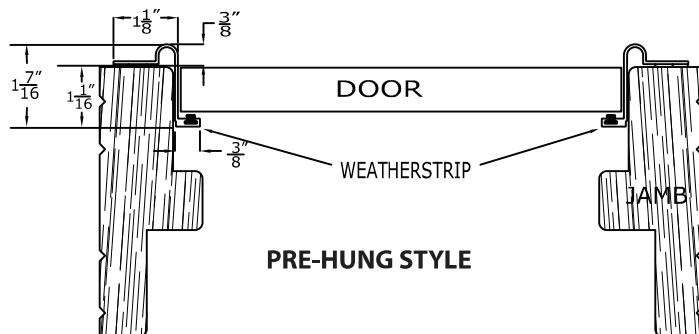

PRE-HUNG STYLE

HINGE EXPANDER STYLE



TRU-FRAME®
A name you can build on.

**Special "C" Tru-Frame® Surface Door
With Amplimesh Grille & Charcoal Aluminum Wire**

ORDER QUOTE (Check One)

DEALER: _____

DATE: _____

JOB NAME/PO#: _____

Completed by: _____

DOOR STYLE (circle one): **C564-Single** or **C568-French**

FINISH: _____

QUANTITY: _____ OUTSIDE SURROUND DIMENSIONS: **WIDTH:** _____ X **HEIGHT:** _____

OPTIONS:

SINGLE:

FRENCH:

SURFACE MOUNT EXTERIOR PRE-HUNG

_____ RIGHT HINGE

_____ OX

_____ LEFT HINGE

_____ XO

(Outside Looking In)

(Outside Looking In)

Locate Punch @ _____" C/L of handle to top of Surround.

Special Notes: _____

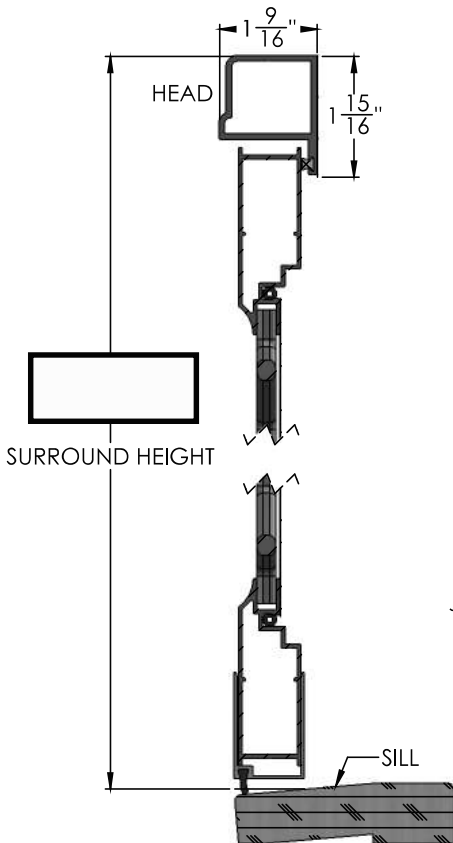

The dimensions for a Tru-Frame® Surface Security Door are derived from the details below (Width) and at left (Height). Measuring by these dimensions will provide a door that will fit your opening.

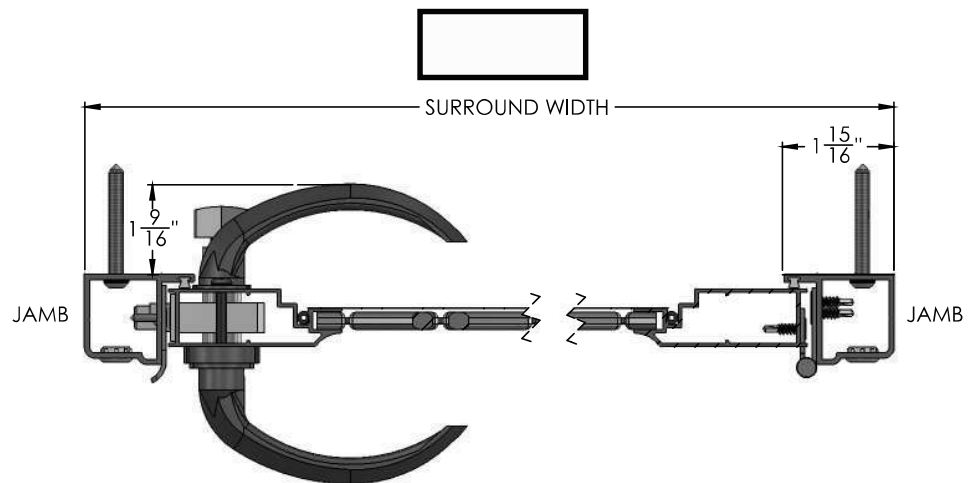



TRU-FRAME®
A name you can build on.

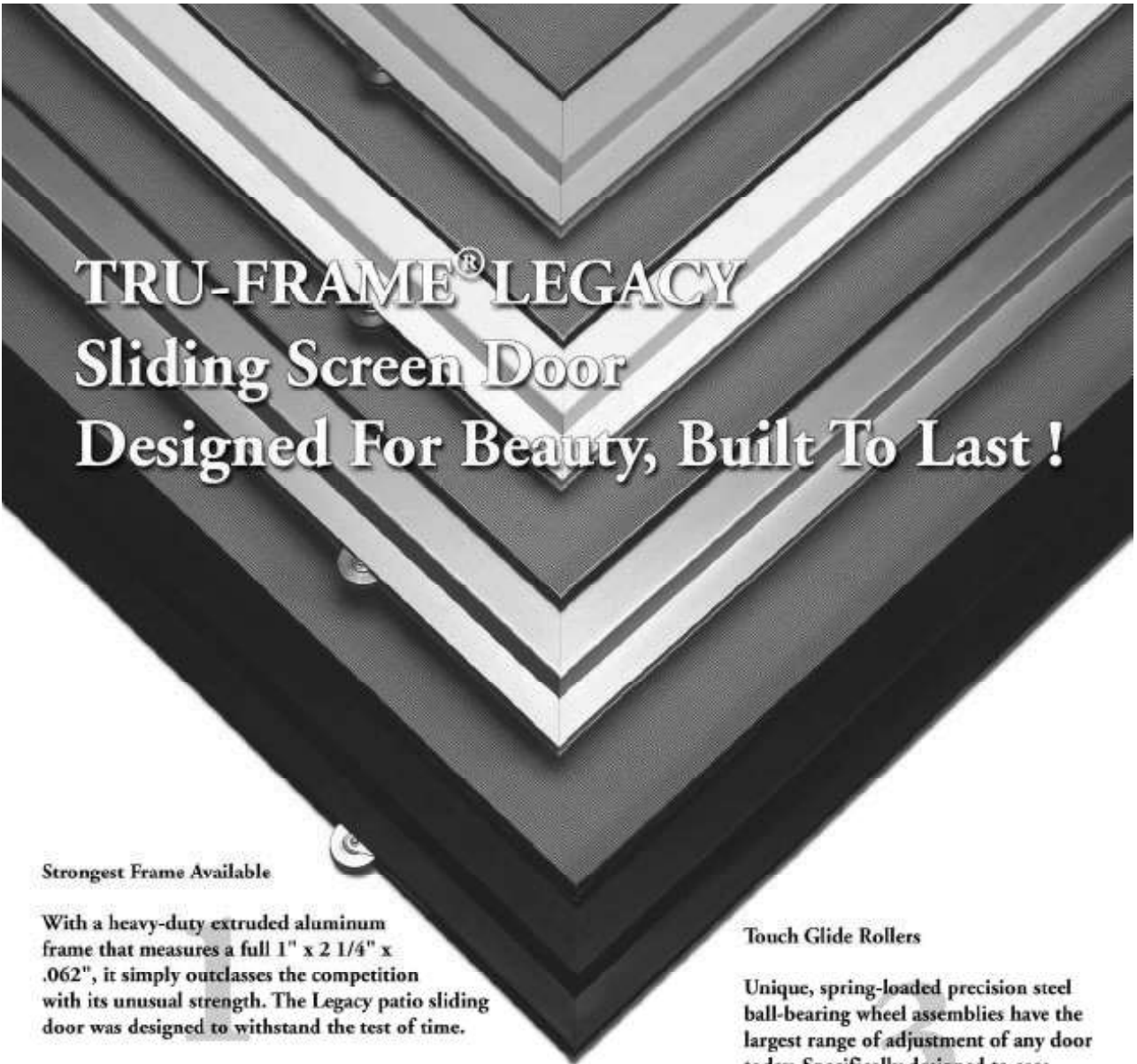

TRU-FRAME® LEGACY Sliding Screen Door Designed For Beauty, Built To Last !

Strongest Frame Available

With a heavy-duty extruded aluminum frame that measures a full 1" x 2 1/4" x .062", it simply outclasses the competition with its unusual strength. The Legacy patio sliding door was designed to withstand the test of time.

Touch Glide Rollers

Unique, spring-loaded precision steel ball-bearing wheel assemblies have the largest range of adjustment of any door today. Specifically designed to ease installation, they prevent the door from jumping the track while allowing for a touch glide.



Auto-Latch Handle System

An all-new Color-Coded Self-Latching handle ensures the door will close correctly every time, and the locking mechanism makes sure it stays that way. The flush handle set is recessed and doesn't project into the screen area—thereby enhancing your view and eliminating screen wear.



For salt air and harsh weather conditions, an all stainless-steel wheel and housing system is now available for the Legacy patio slider. Finally, wheels that last as long as the rest of the door's components.

The Last Screen Door You'll Ever Need.



TRU-FRAME®
A name you can build on.

SLIDING SCREEN DOOR ASSEMBLED- D150



ITEM NO.	SIZE	BR (■), GR (■), WH (□)
D150##F30	31" x 81"	\$174.50
D150##F36	37" x 81"	\$182.00
D150##F48	49" x 81"	\$203.00
D150##F60	61" x 81"	\$220.00
D151##F30	31" x 96"	\$188.50
D151##F36	37" x 96"	\$197.00
D151##F48	49" x 96"	\$218.00
D151##F60	61" x 96"	\$242.50

1 - 3/4" x 1/2" x .038", Roll formed aluminum
18 x 16 Phifer Insect Screen
1 - Vinyl bug seal with flap and tear-off strip
4 - Spring loaded nylon rollers with adjustment screws
1 - Plastic locking latch and handle set (D150)
4 - Spur corner D2061 is standard for D150
4 - Stamped galvanized steel corner D1125 is standard for D151
2 - Top guides
Note: Made to order, size required (See Page 23)

Standard D150

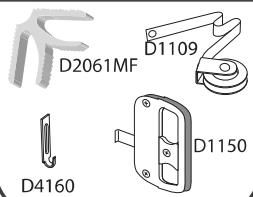

Standard D151

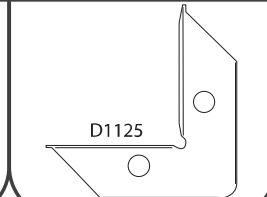

Metal Rollers \$8.50

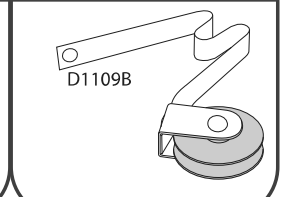

SLIDING SCREEN DOOR ASSEMBLED - D200



ITEM NO.	SIZE	BA (■) SA (■) ##
D200##F36	37" x 81"	\$220.50 \$207.00 \$204.50
D200##F48	49" x 81"	\$255.00 \$232.00 \$224.00
D200##F60	61" x 81"	\$286.00 \$263.00 \$256.50
D200##F72	73" x 81"	\$312.00 \$314.50 \$285.00
D201##F36	37" x 96"	\$240.00 \$227.50 \$224.00
D201##F48	49" x 96"	\$281.50 \$255.00 \$242.50
D201##F60	61" x 96"	\$314.50 \$280.50 \$275.50
D201##F72	73" x 96"	\$345.00 \$314.50 \$314.00

1-7/8" x 1/2" x .050, Extruded aluminum frame (Flat Surface)
18 x 16 Phifer Insect Screen
4 - D2120 - Patented heavy duty die cast corners
4 - D2140B - Spring loaded steel ball bearing rollers with screws
1 - D2021/D2021P - Extruded aluminum handles with D2150 - lever latch housing and mortise lock
2 - D2180 - Top guides
1 - D2112BL (for D200) or D2111BL (for D201) - Vinyl bug seal with flap and tear-off strips
1 - D2160 SS Strike & Screw Assembly
Note: Made to order, size required.

Standard Handle

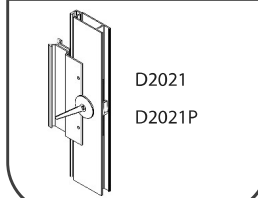

Optional Handle

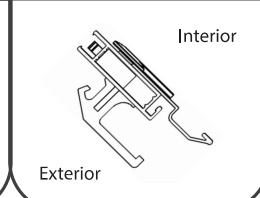

Standard Hardware

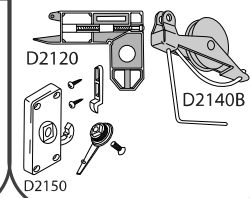

Spur Corner Metal Roller \$8.50

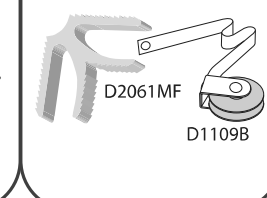

Salt Air Package \$8.50

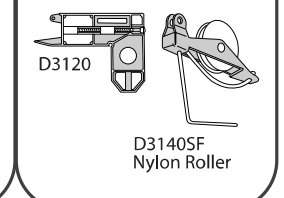

Available finishes: Bronze Anodized (■), Satin Anodized (■)
Painted Finishes: Bronze (■), Champagne Beige (■), Desert Sand (■), White (□)

SUBSTITUTIONS: Optional Hardware for each Series as depicted / Screening Options for all Sliding Screen Doors on Page 33.
NOTE: Customs cannot be cancelled or returned. The ## in the part number represents the finish. Replace ## with your choice of available finishes above. All patio doors are individually skin wrapped except for the 60". Samples are available in 16" x 32" for \$84.00 List.
PACKAGING: See Packaging Chart located in "Shipping Terms and Conditions" to calculate Packaging Fees for orders shipping Common Carrier.

Sliding Patio Door Options: See page 33 for Special Screen Options and Correct Sizing Information.



SLIDING PATIO DOORS MADE TO ORDER

R. Lang Company SECTION D

TRU-FRAME®
A name you can build on.



SLIDING SCREEN DOOR ASSEMBLED - D275

ITEM NO.	SIZE	BA	SA	##
D275##F36	37" x 81"	\$220.50	\$207.00	\$204.50
D275##F48	49" x 81"	\$255.00	\$232.00	\$224.00
D275##F60	61" x 81"	\$286.00	\$263.00	\$256.50
D275##F72	73" x 81"	\$312.00	\$314.50	\$285.00
D276##F36	37" x 96"	\$240.00	\$227.50	\$224.00
D276##F48	49" x 96"	\$281.50	\$255.00	\$242.50
D276##F60	61" x 96"	\$314.50	\$280.50	\$275.50
D276##F72	73" x 96"	\$345.00	\$314.50	\$314.00

- 1-7/8" x 1/2" x .050, Extruded aluminum frame (Ribbed Surface)
- 18 x 16 Phifer Insect Screen
- 4 - D2120 - Patented heavy duty die cast corners
- 4 - D2140B - Spring loaded steel ball bearing rollers with screws
- 1 - D2021/D2021P - Extruded aluminum handles with D2150 - lever latch housing and mortise lock
- 2 - D2180 - Top guides
- 1 - D2112BL (for D200) or D2111BL (for D201) - Vinyl bug seal with flap and tear-off strips
- 1 - D2160 SS Strike & Screw Assembly

Note: Made to order, size required

Standard Handle	Optional Handle	Standard Hardware	Spur Corner Metal Roller \$8.50	Salt Air Package \$8.50
<p>D2021 D2021P</p>	<p>Interior Exterior</p>	<p>D2120 D2140B D2150</p>	<p>D2061MF D1109B</p>	<p>D3120 D3140SF Nylon Roller</p>

Available finishes: Bronze Anodized (■), Satin Anodized (■)
Painted Finishes: Bronze (■), Champagne Beige (■), Desert Sand (■), White (□)

SUBSTITUTIONS: Optional Hardware for each Series as depicted / Screening Options for all Sliding Screen Doors on Page 23.
NOTE: Customs cannot be cancelled or returned. The ## in the part number represents the finish. Replace ## with your choice of available finishes. All patio doors are individually skin wrapped except the 60". Samples are available in 16" x 32" for \$84.00 List.
PACKAGING: See [Packaging Chart](#) located in "Shipping Terms and Conditions" to calculate Packaging Fees for orders shipping Common Carrier.

Sliding Patio Door Options: See page 33 for Special Screen Options and Correct Sizing Information.



TRU-FRAME®
A name you can build on.

PRIMACY SCREEN DOOR ASSEMBLED - D350



ITEM NO.	SIZE	SA	PAINT##
D350##F30	31" x 81"	\$271.00	\$269.00
D350##F36	37" x 81"	\$281.00	\$280.00
D350##F48	49" x 81"	\$301.50	\$298.50
D350##F60	61" x 81"	\$321.00	\$317.00
D351##F30	31" x 96"	\$301.50	\$295.00
D351##F36	37" x 96"	\$314.50	\$309.50
D351##F48	49" x 96"	\$340.00	\$331.00
D351##F60	61" x 96"	\$355.00	\$346.50

- 2-1/2" x 1/2" x .065, Extruded aluminum frame.
- 18 x 16 Phifer Insect Screen
- 4 - D3561MF - Heavy duty extruded aluminum Lok-Tite corners
- 1 - D3520/D3530 - Extruded aluminum handle w/ lever latch and mortise lock set
- 2 - Top guide inserts
- 1 - D2112BL (for D350) or D2111BL (for D351) Vinyl bug seal with flap and tear-off strip
- 2 - D3161 - Top Guides
- 2 - D1148B - 1" Steel BB rollers with flat spring (top rail installation)
- 2 - D1326 - 1-1/4" Steel BB adjustable rollers (bottom rail installation)
- 1 - D2160 SS Strike & Screw Assembly

Note: Made to order, size required

Standard Handle	Standard Hardware	Salt Air Application \$8.50
<p>Interior</p> <p>Exterior</p>	<p>D1148B</p> <p>D1326</p>	<p>D1148</p> <p>D1324</p>

Available finishes: Satin Anodized (■)

Painted Finishes: Bronze (■), Champagne Beige (■), Desert Sand (■), White (□)

LEGACY SCREEN DOOR ASSEMBLED - D500



ITEM NO.	SIZE	BA	SA	##
D500##F30	31" x 81"	\$305.00	\$291.50	\$289.00
D500##F36	37" x 81"	\$319.00	\$302.50	\$297.00
D500##F48	49" x 81"	\$347.50	\$326.00	\$321.00
D500##F60	61" x 81"	\$381.00	\$357.50	\$347.50
D501##F30	31" x 96"	\$335.50	\$321.00	\$317.00
D501##F36	37" x 96"	\$349.00	\$334.00	\$327.50
D501##F48	49" x 96"	\$367.50	\$352.00	\$348.00
D501##F60	61" x 96"	\$422.00	\$368.50	\$384.00

- 2-1/4" x 1" x .060 Extruded aluminum.
- 18 x 16 Phifer Insect Screen
- 4 - D5061MF - 3" Heavy duty extruded aluminum Lok-Tite corners
- 4 - D5120B - 1" Steel ball bearing wheel assemblies (Pre-installed)
- 1 - D5467 - Flush mounted aluminum die cast handle (Spring Latch)
- 1 - D2112BL (for D500) or D2111BL (for D501) Vinyl bug seal with flap and tear-off strip
- 2 - D2180 - PVC top guides
- 1 - D5110BL Optional Manual Latch Handle
- 1 - D2160 SS Strike & Screw Assembly

Note: Made to order, size required

Standard	Manual Latch Hardware \$10.00	Salt Air Application \$10.00	Nylon Roller \$10.00
<p>D5467</p> <p>D5120B</p>	<p>D5110BL</p>	<p>D5120SS</p>	<p>D5120NSS</p>

SUBSTITUTIONS: Optional Hardware for each Series as depicted / Screening Options for all Sliding Screen Doors on Page 31.

NOTE: Custom Doors can not be cancelled or returned. Doors are handed, specify XO or OX when ordering D350 & D500.

Special latch placement or roller slotting..... Add \$8.00 List

Special sizes larger than listed..... Call for quote

Sample is available in 16" x 32"..... \$106.50 List

PACKAGING: See Packaging Chart located in "Shipping Terms and Conditions" to calculate Packaging Fees for orders shipping Common Carrier.

Available finishes: Bronze Anodized (■), Satin Anodized (■)

Painted Finishes: Bronze (■), Champagne Beige (■), Desert Sand (■), White (□)



TRU-FRAME®
A name you can build on.

SCREENING OPTIONS

Add the following to the LIST PRICE of any Assembled Sliding Patio Door Screen

Vision Enhancing & Aluminum	Up To 36" x 96"	Up To 48" x 96"	Up To 60" x 96"	Sun Control & Pet Control	Up To 36" x 96"	Up To 48" x 96"	Up To 60" x 96"
18 x 16 Phifer Insect	Standard	Standard	Standard	Suntex 80%	\$42.00	\$50.00	\$60.00
BetterVue if Requested	Free	Free	Free	Suntex 90%	\$50.00	\$60.00	\$70.00
UltraVue	\$30.00	\$32.50	\$35.00	Super Solar 90%	\$50.00	\$60.00	\$70.00
Brite Aluminum	\$18.00	\$22.00	\$27.00	Tuff Screen	\$35.00	\$42.50	\$50.00
Charcoal Aluminum	\$19.00	\$23.50	\$29.00	Pet Screen	\$38.00	\$47.50	\$57.50
18x14 Fiberglass Mesh	\$17.00	\$18.50	\$20.00	Brite Bronze	\$90.00	\$115.00	\$150.00
No-See-Um	\$37.50	\$45.00	\$55.00				

Measurements of actual door: W ____ " x H ____ " = NET DOOR SIZE

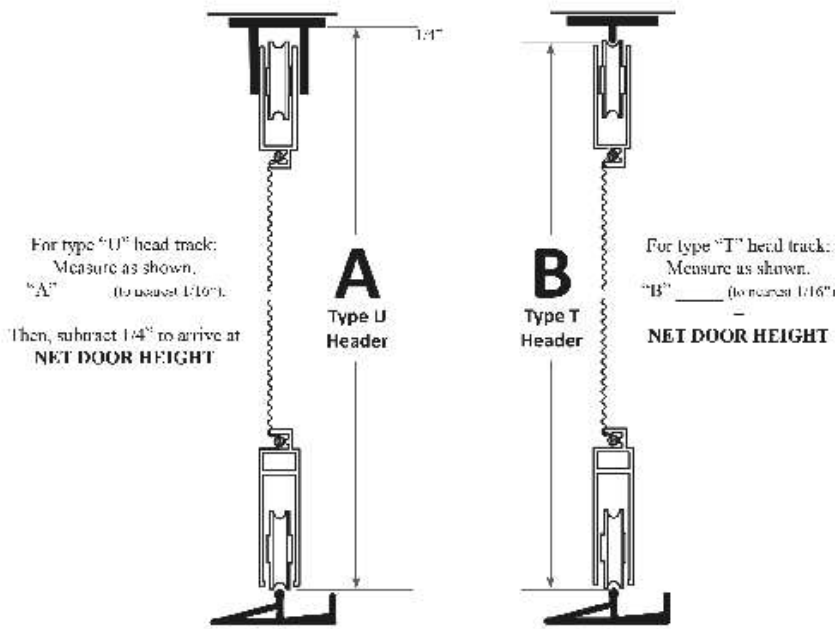

PATIO SLIDER HEIGHT:
Please use the illustration to the left as an aid in determining proper Patio Slider Screen Height

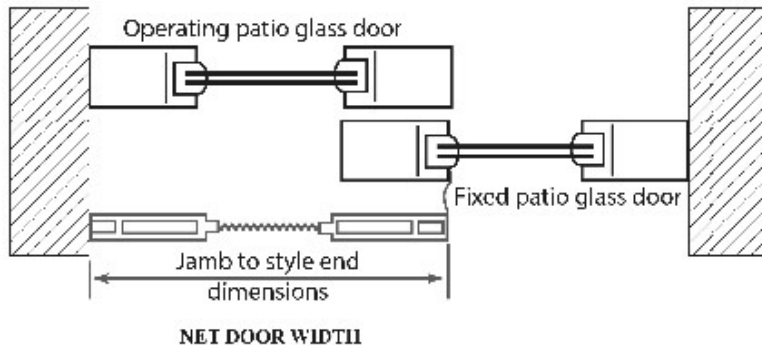

PATIO SLIDER WIDTH:
Please use the illustration to the left as an aid in determining proper Patio Slider Screen Width

Sliding Patio Door Info: Please visit our website at www.Truframe.com/catalog for additional order forms, brochures, installation instructions & more on our entire product line.



TRU-FRAME®
A name you can build on.

SLIDING SCREEN DOOR KD KIT - D150

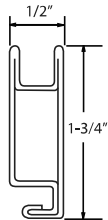

ITEM NO.	SIZE	Bronze (■), Gray (■), White (□)
D150##K30	31" x 81"	\$131.00
D150##K36	37" x 81"	\$135.00
D150##K48	49" x 81"	\$144.50
D150##K60	61" x 81"	\$157.00
D151##K30	31" x 97"	\$142.50
D151##K36	37" x 97"	\$149.00
D151##K48	49" x 97"	\$159.50
D151##K60	61" x 97"	\$173.50

Series 150 KD Kit Parts List:

- 2 - Roll Formed aluminum rails, 1-3/4" x 1/2" x 0.038 widths
- 1 - Roll Formed aluminum stile, 1-3/4" x 1/2" x 0.038", drilled at center for handle
- 1 - Roll Formed aluminum stile, 1-3/4" x 1/2" x 0.038", blank
- 4 - D2061 - Spur corner
- 4 - D1109 - Spring loaded nylon rollers with adjustment screws
- 1 - D1130 - Plastic locking latch and handle set
- 1 - D4110BL - Vinyl bug seal with flap and tear-off strip
- 2 - D4180 - Top guides

Standard Hardware

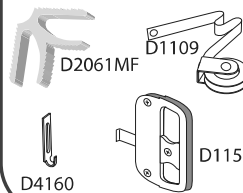

Metal Rollers \$8.50

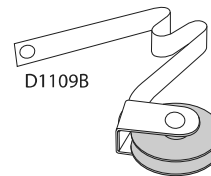

SLIDING SCREEN DOOR KD KIT - D200

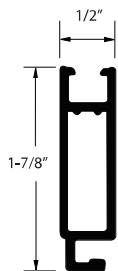

ITEM NO.	SIZE	BA	SA	##
D200##K30	32" x 81"	\$163.50	\$146.50	\$146.50
D200##K36	38" x 81"	\$169.50	\$151.50	\$151.50
D200##K48	50" x 81"	\$180.50	\$164.00	\$164.00
D200##K60	62" x 81"	\$197.00	\$175.50	\$175.50
D201##K30	32" x 97"	\$178.50	\$161.50	\$159.00
D201##K36	38" x 97"	\$186.50	\$168.50	\$162.50
D201##K48	50" x 97"	\$197.50	\$183.50	\$177.50
D201##K60	62" x 97"	\$215.00	\$193.50	\$185.50

Series 200 KD Kit Parts List:

- 2 - Extruded rails, 1-7/8" x 1/2" x .050, for widths (Flat Surface)
- 1 - Cambered extruded aluminum stile Extruded rails, 1-7/8" x 1/2" x .050, drilled for handle
- 1 - Extruded rails, 1-7/8" x 1/2" x .050, blank
- 4 - D2120 - Patented heavy duty die cast corners
- 4 - D2140B - Spring loaded steel ball bearing rollers with adjustment screws
- 1 - D2021/D2021P - Extruded aluminum handles with D2150 - lever latch housing and mortise lock set
- 2 - D2180 - Top guides
- 1 - D2112BL (for D200) or D2111BL (for D201) - Vinyl bug seal with flap and tear-off strip
- 1 - D2160 SS Strike & Screw Assembly

Standard Handle

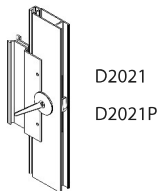

Optional Handle

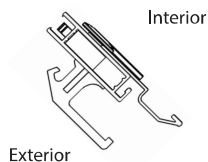

Standard Hardware

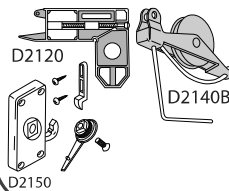

Spur Corner Metal Roller \$8.50

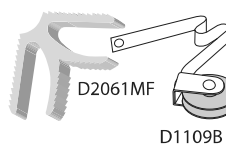

Salt Air Application \$8.50

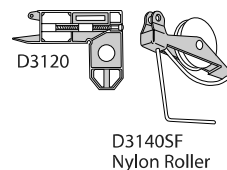

Available finishes: Bronze Anodized (■), Satin Anodized (■)
Painted Finishes: Bronze (■), Champagne Beige (■), Desert Sand (■), White (□)

NOTE: Special latch placement or roller slottingAdd \$8.00 List Each
 Special sizes - straight cut - next larger sizeAdd \$8.00 List Each
 Pre cut and mitered to size.Add \$8.00 List Each
 Special sizes larger than listed.Call for quote

PACKAGING: Series 150 and 200 KD Kits are packed 6 per size, per finish, per carton. Doors are priced based on full carton purchase. Size and Finishes may be combined to achieve full carton pricing. **Add \$4.00 List (per door) when purchasing in less than full carton quantities.** See [Packaging Chart](#) located in "Shipping Terms and Conditions" to calculate Packaging Fees for orders shipping Common Carrier.



TRU-FRAME®
A name you can build on.

SLIDING SCREEN DOOR KD KIT - D275

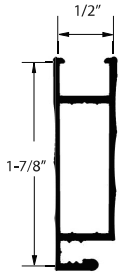

ITEM NO.	SIZE	BA	SA	##
D275##K30	32" x 81"	\$163.50	\$146.50	\$146.50
D275##K36	38" x 81"	\$169.50	\$151.50	\$151.50
D275##K48	50" x 81"	\$180.50	\$164.00	\$164.00
D275##K60	62" x 81"	\$197.50	\$175.50	\$175.50
D276##K30	32" x 97"	\$178.50	\$161.50	\$159.00
D276##K36	38" x 97"	\$186.50	\$168.50	\$162.50
D276##K48	50" x 97"	\$197.50	\$183.50	\$177.50
D276##K60	62" x 97"	\$215.00	\$193.50	\$185.50

Series 275 KD Kit Parts List:

- 2 - Extruded rails, 1-7/8" x 1/2" x .050, for widths (Ribbed Surface)
- 1 - Cambered extruded aluminum stile Extruded rails, 1-7/8" x 1/2" x .050, drilled for handle
- 1 - Extruded rails, 1-7/8" x 1/2" x .050, blank
- 4 - D2120 - Patented heavy duty die cast corners
- 4 - D2140B - Spring loaded steel ball bearing rollers with adjustment screws
- 1 - D2021/D2021P - Extruded aluminum handles with D2150 - lever latch housing and mortise lock set
- 2 - D2180 - Top guides
- 1 - D2112BL (for D200) or D2111BL (for D201) - Vinyl bug seal with flap and tear-off strip
- 1 - D2160 SS Strike & Screw Assembly

Standard Handle	Optional Handle	Standard Hardware	Spur Corner Metal Roller \$8.50	Salt Air Application \$8.50
<p>D2021 D2021P</p>	<p>Interior Exterior</p>	<p>D2120 D2150 D2140B</p>	<p>DD2061MF D1109B</p>	<p>D3120 D3140SF Nylon Roller</p>

Available finishes: Bronze Anodized (■), Satin Anodized (▨)
Painted Finishes: Bronze (■), Champagne Beige (■), Desert Sand (■), White (□)

NOTE: Special latch placement or roller slottingAdd \$8.00 List Each
 Special sizes - straight cut - next larger sizeAdd \$8.00 List Each
 Pre cut and mitered to size.Add \$8.00 List Each
 Special sizes larger than listed.Call for quote

PACKAGING: Series 275 KD Kits are packed 6 per size, per finish, per carton. Doors are priced based on full carton purchase. Size and Finishes may be combined to achieve full carton pricing. **Add \$4.00 List (per door) when purchasing in less than full carton quantities.** See Packaging Chart located in "Shipping Terms and Conditions" to calculate Packaging Fees for orders shipping Common Carrier.



TRU-FRAME®
A name you can build on.

PRIMACY SCREEN DOOR KD KIT - D350

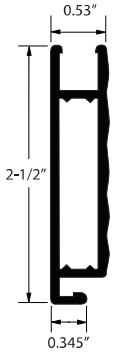

ITEM NO.	SIZE	SA	PAINT##
D350##K30	32" x 81"	\$213.00	\$209.00
D350##K36	38" x 81"	\$217.50	\$216.00
D350##K48	50" x 81"	\$231.50	\$229.50
D350##K60	62" x 81"	\$246.50	\$244.50
D351##K30	32" x 97"	\$231.50	\$233.50
D351##K36	38" x 97"	\$237.50	\$240.50
D351##K48	50" x 97"	\$243.50	\$245.50
D351##K60	62" x 97"	\$255.00	\$255.50

Series 350 KD Kit Parts List:

- 2 - Extruded aluminum rails, 2-1/2" x 1/2" x .065"
- 1 - Cambered extruded aluminum stiles, 2-1/2" x 1/2" x .065"
- 1 - D3520/D3530 - Extruded aluminum handles with D2150 - lever latch housing and mortise lock set
- 4 - D3561 MF - Heavy duty extruded aluminum Lok-Tite corners
- 2 - D3570 - Binding post with screw
- 1 - D2112BL (for D350) or D2111BL (for D351) - Vinyl bug seal with flap and tear-off strips
- 2 - D3161 - Top guides
- 2 - D1148B - 1" Steel BB rollers with flat spring (top rail installation)
- 2 - D1326 - 1-1/4" Steel BB adjustable rollers (bottom rail installation)
- 1 - D2160 SS Strike & Screw Assembly

Standard Handle

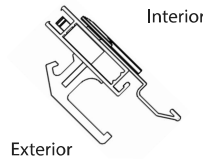

Standard Hardware

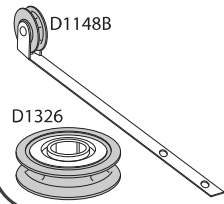

Salt Air Application \$8.50

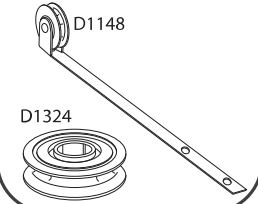

Available finishes: Satin Anodized (■)

Painted Finishes: Bronze (■), Champagne Beige (■), Desert Sand (■), White (□)

LEGACY SCREEN DOOR KD KIT- D500

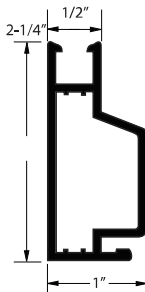

ITEM NO.	SIZE	BA	SA	##
D500##K30	32" x 81"	\$257.00	\$229.50	\$230.50
D500##K36	38" x 81"	\$264.00	\$237.00	\$235.00
D500##K48	50" x 81"	\$285.00	\$250.50	\$247.00
D500##K60	62" x 81"	\$304.50	\$269.50	\$262.00
D501##K30	32" x 97"	\$285.00	\$261.00	\$262.00
D501##K36	38" x 97"	\$294.50	\$269.50	\$270.50
D501##K48	50" x 97"	\$310.50	\$280.50	\$285.00
D501##K60	62" x 97"	\$330.50	\$299.00	\$301.00

Series 500 KD Kit Parts List:

- 2 - Extruded aluminum rails, 2-1/4" x 1/2" x .060"; for widths with custom steel ball bearing wheel assemblies installed
- 1 - Cambered extruded aluminum stile, 2-1/4" x 1/2" x .060"; with flush mount handle installed, XO configuration, reversible latch.
- 1 - Cambered extruded aluminum stile, 2-1/4" x 1/2" x .060"; blank
- 4 - D5061 MF - Heavy duty extruded aluminum Lok-Tite corners
- 1 - D5467 - Flush mounted aluminum die cast handle (Self Latching)
- 1 - D2112BL (for D500) or D2111BL (for D501) - Vinyl bug seal with flap and tear-off strip
- 2 - Top guides
- 1 - D2160 SS Strike & Screw Assembly

Standard

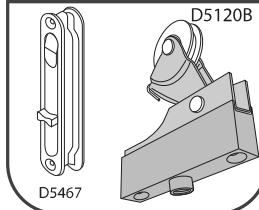

Manual Latch Hardware \$10.00

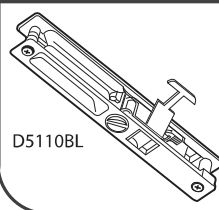

Salt Air Application \$10.00

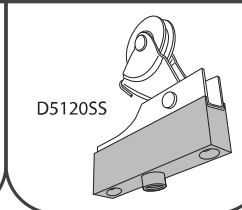

Nylon Roller \$10.00

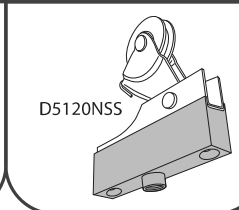

Available finishes: Bronze Anodized (■), Satin Anodized (■)

Painted Finishes: Bronze (■), Champagne Beige (■), Desert Sand (■), White (□)

NOTE:
Special latch placement or roller slottingAdd \$8.00 List Each
Special sizes - straight cut - next larger sizeAdd \$8.00 List Each
Pre cut and mitered to sizeAdd \$8.00 List Each
Special sizes larger than listedCall for quote

PACKAGING: Series 350 and 500 KD Kits are individually wrapped in plastic and priced as single units (carton pricing not required). See [Packaging Chart](#) located in "Shipping Terms and Conditions" to calculate Packaging Fees for orders shipping Common Carrier.



**SLIDING PATIO DOORS
ASSEMBLED / ADJUSTABLE**

R. Lang Company
SECTION D

TRU-FRAME®
A name you can build on.



TRU-SLIDE™ - D250

ITEM NO.	SIZE	BR	SA	WH
D250##F30	30"	\$231.50	\$242.50	\$231.50
D250##F36	36"	\$240.50	\$254.50	\$240.50
D250##F48	48"	\$270.00	\$288.00	\$270.00
D250##F60	60"	\$293.00	\$312.50	\$293.00

1-7/8" x 1/2" x .050 Extruded aluminum frame
Extruded aluminum handles with lever latch housing and mortise lock set
Heavy duty extruded aluminum Lok-Tite corners
Smooth sliding steel ball bearing wheels
Vinyl bug seal with flap and tear-off strip
18 x 16 Phifer Insect Screen
Adjusts to fit opening from 78-1/2" to 81"



TRU-SLIDE™ with Pushbars - D250

ITEM NO.	SIZE	BR	SA	WH
D250##F30Y	30"	\$243.00	\$254.50	\$243.00
D250##F36Y	36"	\$253.00	\$267.00	\$253.00
D250##F48Y	48"	\$283.00	\$301.50	\$283.00
D250##F60Y	60"	\$306.00	\$326.50	\$306.00

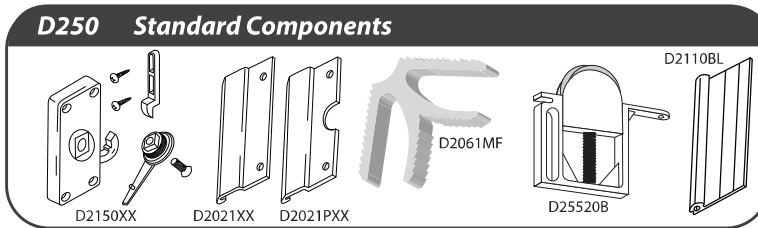

1-7/8" x 1/2" x .050 Extruded aluminum frame
Extruded aluminum handles with lever latch housing and mortise lock set
Heavy duty extruded aluminum Lok-Tite corners
Smooth sliding steel ball bearing wheels
Vinyl bug seal with flap and tear-off strip
18 x 16 Phifer Insect Screen
Adjusts to fit opening from 78-1/2" to 81"
2 push bars

SUBSTITUTIONS: Screening Options for all Sliding Screen Doors on Page 33.



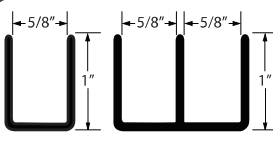
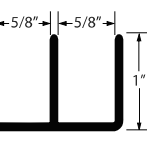
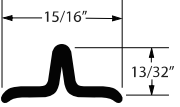
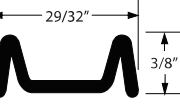
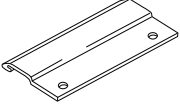
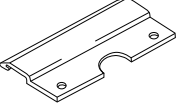

TRU-FRAME®
A name you can build on.

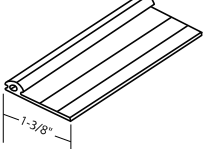
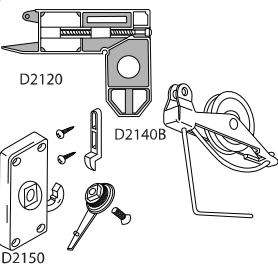
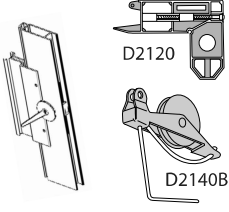
Item No.	Description	Length	Per Pkg	Per Piece	Per Box
EXTRUDED CHANNEL					
List Price					
 Single Channel	D2211SA, ##	5/8" x 1" Extruded Single Channel	144"		\$47.50
 Double Channel	D2221SA, ##	5/8" x 1" Extruded Double Channel	144"		\$66.50
EXTRUDED SINGLE BOTTOM TRACK					
	D2231SA, ##	Extruded Single Bottom Track	144"		\$37.00
EXTRUDED DOUBLE BOTTOM TRACK					
	D2241SA, ##	Extruded Double Bottom Track	144"		\$44.50
D200 EXTRUDED PATIO DOOR HANDLE					
	D2021SA, BA, ##	4" Extruded Patio Door Handle			\$8.00
D200 EXTRUDED PATIO DOOR HANDLE - PUNCHED					
	D2021PSA, BA, ##	4" Extruded Patio Door Handle - Punched			\$8.00
EXTRUDED SPUR CORNER					
	D2061MF	Extruded Spur Corner		25	\$4.00 \$100.00
BUG SEAL					
	D2110BL	Bug Seal - Extruded Patio Door - Roll	250'		\$167.50
	D2111BL	Bug Seal - Extruded Patio Door - Strip	96"	10	\$10.00 \$100.00
	D2112BL	Bug Seal - Extruded Patio Door - Strip	81"	10	\$9.00 \$90.00
D200 COMPONENTS					
	D2120	Die Cast Corner with Adjustment Screw		25	\$5.50 \$137.50
	D2140	1" Nylon Adjustable Tension Roller		25	\$5.00 \$125.00
	D2140B	1" Steel BB Adjustable Tension Roller		25	\$6.00 \$150.00
	D2150GR, BR, WH	Mortise Latch and Strike Assembly		10	\$18.00 \$180.00
	D2160	Die Cast Strike & Screw Assembly		25	\$2.50 \$62.50
	D2180	Top Guide Clip Green		100	\$1.00 \$100.00
	D25520B	1" Tru-Slide BB Wheel Assembly		25	\$10.00 \$250.00
D200 KD KIT HARDWARE					
	D24200SA, BA, ##	D200 Handle Kit Only (no roller/corner/guides)			\$18.50
	D25200SA, BA, ##	D200 KD Kit Hardware Pack (Items Incl. Below)			\$41.00
D25200 Includes:					
4 - Die Cast Corners		4 - BB Rollers with Adjustment Screws			
1 - Set Extruded Handles		1 - Mortise Latch with Strike & Screws			
2 - Top Guides		1 - Fabrication Instruction Sheet			

Add 15% packaging fee for all D Section components not purchased in standard carton quantities as noted above

Available finishes: Bronze Anodized (■), Satin Anodized (□)
Painted Finishes: Bronze (■), Champagne Beige (■), Desert Sand (□), White (□)



TRU-FRAME®
A name you can build on.

Item No. Description Length Per Pkg Per Piece Per Box

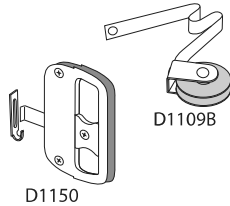

D150 COMPONENTS

D1109	Nylon Roller WH/W Spring 1 in.		25	\$4.00	\$100.00
D1109B	Steel BB Roller WH/W Spring 1in.		25	\$5.00	\$125.00
D1130	KD Hardware Kit D150/D400		1	\$12.50	-
D1148B	5-1/4 Straight Spring RLR 1 Stl BB		10	\$7.00	\$70.00
D1150	D150 handle Assembly /550		1	\$16.00	-
D1326	Steel B.B. Roller 1-1/4 O.D.		10	\$7.00	\$70.00
D1273	T Turn Latch w/Stop and Screw Assembly		1	\$6.00	-



D350 COMPONENTS

D3570	D350 Binding Post & Screw Zinc		25	\$4.00	\$100.00
D3140SF	1 1/4" Nylon Wheel / Roller Assembly		10	\$7.50	\$75.00

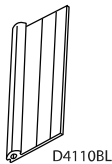

D400 COMPONENTS

D4110BL	Vinyl Bugstrip 250ft. Black		1	\$175.00	-
D4112BL	Vinyl Bugstrip 81in. BL/25/Box		25	\$6.00	\$150.00
D4160	Replace-All Srtike 600-17J		25	\$3.00	\$75.00
D4180	Top Guide Clip-Clear		10	\$1.00	\$10.00

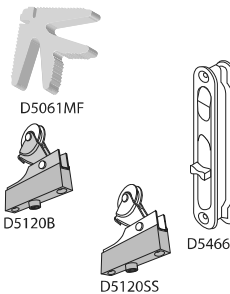

D500 COMPONENTS

D5061MF	D500 Legacy Corner Key - Cut Pieces		25	\$8.00	\$200.00
D5120B	D500 Standard Roller Assembly		10	\$6.00	\$60.00
D5120NSP	D500 Nylon Roller Assembly		10	\$12.50	\$125.00
D5120SS	D500 Stainless Steel Roller Assembly		10	\$12.50	\$125.00
D5145	D500 Locking Latch		25	\$3.50	\$87.50
D5145SS	D500 Stainless Steel Locking Latch		25	\$4.00	\$100.00
D5466BL, WH	D500 Toggle Handle Assembly		1	\$26.50	-
D5140B	D500 Steel BB Roller only		10	\$5.00	\$50.00
D5140SS	D500 Stainless Steel Roller & Rivet		10	\$7.00	\$70.00



DISPLAYS AND HAND SAMPLES

DDS050BL	Counter Top Patio Slider Display & Sign Only		1	\$595.00	-
D150##SMPL	Series 150 Patio Door Slider Sample - 16" x 32"		1	\$91.00	-
D200##SMPL	Series 200 Patio Door Slider Sample - 16" x 32"		1	\$101.00	-
D275##SMPL	Series 275 Patio Door Slider Sample - 16" x 32"		1	\$101.00	-
D350##SMPL	Primacy D350 Patio Slider Sample - 16" x 32"		1	\$120.00	-
D500##SMPL	Legacy D500 Patio Slider Sample - 16" x 32"		1	\$128.00	-

Add 15% packaging fee for all D Section components not purchased in standard carton quantities as noted above

Available finishes: Bronze Anodized (■), Satin Anodized (□)
Painted Finishes: Bronze (■), Champagne Beige (■), Desert Sand (□), White (□)



TRU-FRAME®
A name you can build on.

Item No. Description Length Per Pkg Per Piece Per Box

EXTRUDED PATIO FRAME

List Price

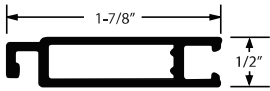

D2010BA	Extruded Patio Frame	202.5"	24	\$115.00	\$2,760.00
D2010SA	Extruded Patio Frame	202.5"	24	\$106.00	\$2,544.00
D2010##	Extruded Patio Frame	202.5"	24	\$98.50	\$2,364.00
D2012BA	Extruded Patio Frame - Cambered	97"	1	\$60.50	
D2012SA	Extruded Patio Frame - Cambered	97"	1	\$48.50	
D2012##	Extruded Patio Frame - Cambered	97"	1	\$47.00	
D2013BA	Extruded Patio Frame - Cambered	81"	1	\$59.00	
D2013SA	Extruded Patio Frame - Cambered	81"	1	\$53.50	
D2013##	Extruded Patio Frame - Cambered	81"	1	\$45.00	

EXTRUDED PATIO FRAME - Side Rails

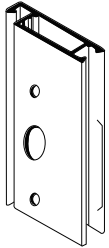

D2012PBA	Extruded Patio Frame - Punched - Cambered	97"	1	\$72.50	
D2012PSA	Extruded Patio Frame - Punched - Cambered	97"	1	\$59.00	
D2012P##	Extruded Patio Frame - Punched - Cambered	97"	1	\$57.00	
D2013PBA	Extruded Patio Frame - Punched - Cambered	81"	1	\$63.50	
D2013PSA	Extruded Patio Frame - Punched - Cambered	81"	1	\$59.00	
D2013P##	Extruded Patio Frame - Punched - Cambered	81"	1	\$50.50	

EXTRUDED PATIO FRAME - Top & Bottom Rail

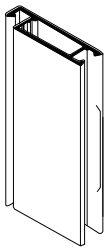

D2015PBA	Extruded Patio Frame - Punched	62"	1	\$40.00	
D2015PSA	Extruded Patio Frame - Punched	62"	1	\$36.00	
D2015P##	Extruded Patio Frame - Punched	62"	1	\$34.00	
D2016PBA	Extruded Patio Frame - Punched	50"	1	\$35.50	
D2016PSA	Extruded Patio Frame - Punched	50"	1	\$33.00	
D2016P##	Extruded Patio Frame - Punched	50"	1	\$32.00	
D2017PBA	Extruded Patio Frame - Punched	38"	1	\$32.00	
D2017PSA	Extruded Patio Frame - Punched	38"	1	\$27.00	
D2017P##	Extruded Patio Frame - Punched	38"	1	\$27.00	
D2018PBA	Extruded Patio Frame - Punched	32"	1	\$27.00	
D2018PSA	Extruded Patio Frame - Punched	32"	1	\$27.00	
D2018P##	Extruded Patio Frame - Punched	32"	1	\$24.50	

EXTRUDED PATIO ASTRAGAL

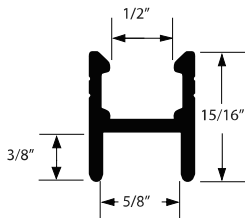

D2030BA	Extruded Patio Astragal	96"	1	\$62.00	
D2030SA	Extruded Patio Astragal	96"	1	\$56.50	
D2030##	Extruded Patio Astragal	96"	1	\$50.00	
D2031BA	Extruded Patio Astragal	84"	1	\$58.00	
D2031SA	Extruded Patio Astragal	84"	1	\$52.00	
D2031##	Extruded Patio Astragal	84"	1	\$46.00	

Available finishes: Bronze Anodized (■), Satin Anodized (□)

Painted Finishes: Bronze (■), Champagne Beige (■), Desert Sand (□), White (□)



ORDER / QUOTE FORM

R. Lang Company

TRU-FRAME®
A name you can build on.

ORDER QUOTE (Check One)

Sliding Patio Doors (Series D150, D200, D350)
Fax Number: 888-526-4329

DATE: _____

DEALER: _____

Completed by: _____

JOB NAME/PO#: _____

DOOR STYLE: D150 D200 D350 (circle one)

Quantity: _____ XO _____ OX _____

Frame Color: _____ (See Section D)

Net Size: _____ x _____

Fiberglass _____ Alum. _____ Other _____ (See Section F)

DOOR STYLE: D150 D200 D350 (circle one)

Quantity: _____ XO _____ OX _____

Frame Color: _____ (See Section D)

Net Size: _____ x _____

Fiberglass _____ Alum. _____ Other _____ (See Section F)

DOOR STYLE: D150 D200 D350 (circle one)

Quantity: _____ XO _____ OX _____

Frame Color: _____ (See Section D)

Net Size: _____ x _____

Fiberglass _____ Alum. _____ Other _____ (See Section F)

DOOR STYLE: D150 D200 D350 (circle one)

Quantity: _____ XO _____ OX _____

Frame Color: _____ (See Section D)

Net Size: _____ x _____

Fiberglass _____ Alum. _____ Other _____ (See Section F)

SLIDES RIGHT ⇔ X	FIXED O
----------------------------------	-----------------------

FIXED O	SLIDES LEFT ⇐ X
-----------------------	---------------------------------

(Always viewed from exterior)

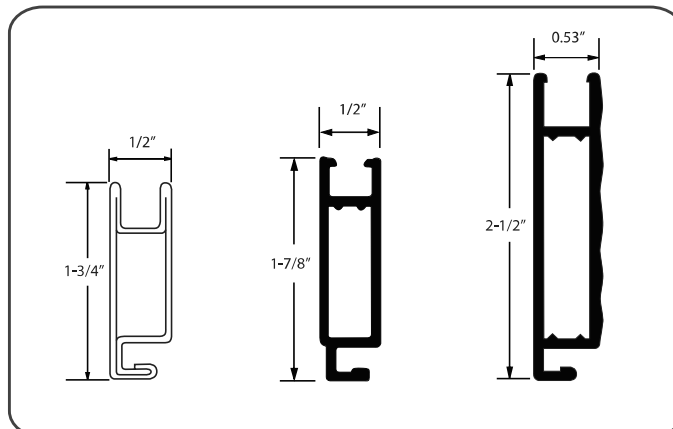



TRU-FRAME®
A name you can build on.

ORDER QUOTE (Check One)

D500 Legacy Patio Door
Fax Number: 888-526-4329

DATE: _____

DEALER: _____

Completed by: _____

JOB NAME/PO#: _____

Quantity: _____ XO _____ OX _____

Frame Color: _____

Net Size: _____ x _____

Mesh Required: _____

Quantity: _____ XO _____ OX _____

Frame Color: _____

Net Size: _____ x _____

Mesh Required: _____

Quantity: _____ XO _____ OX _____

Frame Color: _____

Net Size: _____ x _____

Mesh Required: _____

Quantity: _____ XO _____ OX _____

Frame Color: _____

Net Size: _____ x _____

Mesh Required: _____

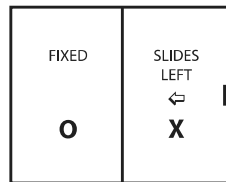
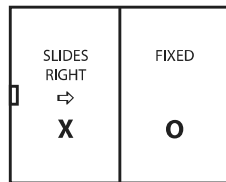

(Always viewed from exterior)

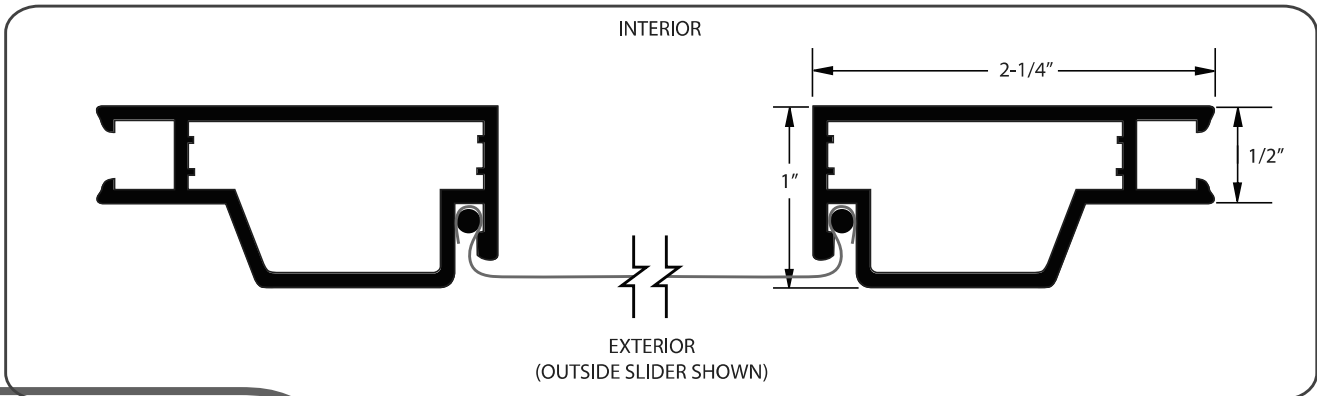

SECTION D

SECTION E



TRU-FRAME®
A name you can build on.

Protecto Grille

For the finest screen door protection.

Protect screen doors from damage by pets and children with strong, attractive Protecto Grilles from Tru-Frame®. All aluminum construction – will not rust like steel. Available in 30", 36", 48" and 60" sizes for sliding doors, and 30", 32", and 36" for swinging doors.

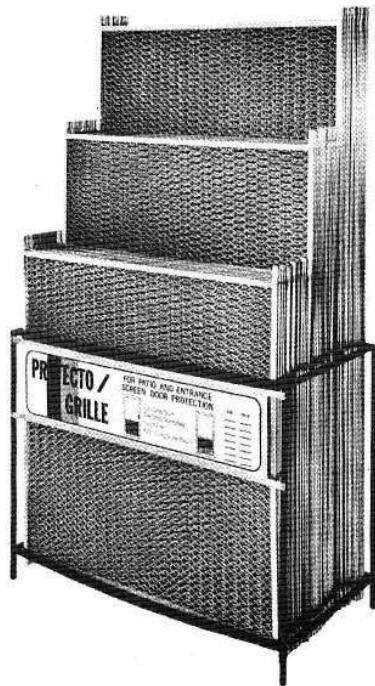

Display rack (shown above) is available. Refer to 'Floor Displays and Hand Samples' section in the front of the Catalog for more information.

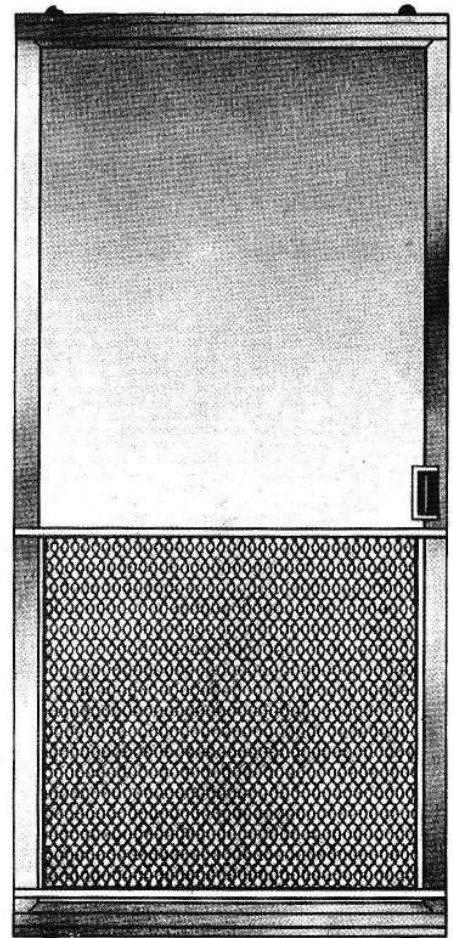



TRU-FRAME®
A name you can build on.

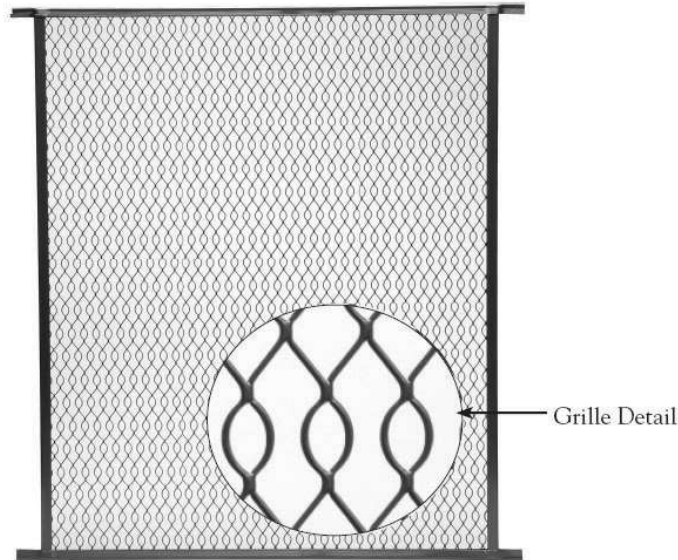

PART NO.	DESCRIPTION	Mill Finish Price/Single	Painted Price/Single
ESS##30	30-SS Fits 30" Sliding Door	\$59.50	\$67.50
ESS##36	36-SS Fits 36" Sliding Door	\$65.50	\$76.00
ESS##48	48-SS Fits 48" Sliding Door	\$79.50	\$92.50
ESS##60	60-SS Fits 60" Sliding Door	\$95.50	\$109.00
ESH##30	30-SH Fits 30" Hinged Door	\$50.00	\$60.00
ESH##32	32-SH Fits 32" Hinged Door	\$52.00	\$61.50
ESH##36	36-SH Fits 36" Hinged Door	\$54.50	\$65.50

PART NO.	DESCRIPTION		
EDS100BL	Display Rack with Sign (Holds up to 48 Grilles)		\$600.00
EDS101	Display Sign Only		\$85.00

PACKAGING: See [Packaging Chart](#) located in "Shipping Terms and Conditions" to calculate Packaging Fees for orders shipping Common Carrier.

SPECIALS: Add \$30.00 to list price for next largest size for custom size grilles.

NOTE: ESS = Sliding Door Grilles Height 33 3/4"
ESH = Hinged Door Grilles Height 24"

Available finishes: Mill Finish (▨)

Painted Finishes: Statuary Bronze (■), Champagne Beige (■), Desert Sand (□), White (□)



TRU-FRAME®
A name you can build on.

ORDER QUOTE (Check One)

Special Size Pet Grille (Sliding Door Grille) Order Form
Fax Number: 888-526-4329

DATE: _____

DEALER: _____

JOB NAME/PO#: _____

Completed by: _____

ESS (Sliding Door Grille) Standard Grille Height = 33-1/2"

Quantity _____

Color: White _____ Bronze _____ Mill Finish _____ Desert Sand _____ Champagne Beige _____

Special Paint (specify color) _____

HEIGHT _____

(used for grilles shorter than standard height)

Max height: 33-1/2" TAB-to-TAB

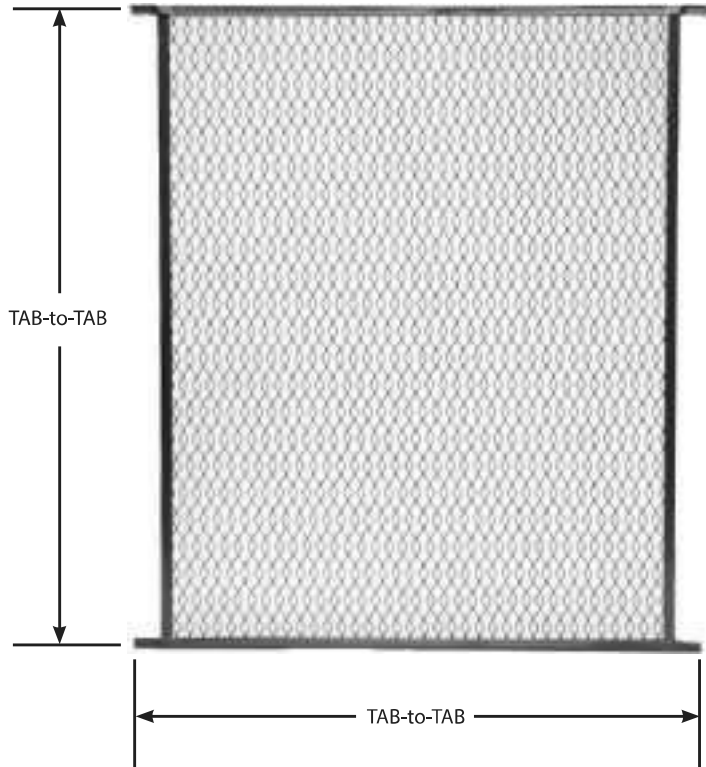

WIDTH _____

Max width: 59-1/2" TAB-to-TAB

Special Size = Net Door Size minus 1/4" for TAB-to-TAB size

Example: Standard size ESSWH36 = 35-3/4" TAB-to-TAB width.
Actual Grille Size = W 32-3/4" x H 33" (without tabs).

SECTION E



TRU-FRAME®
A name you can build on.

ORDER QUOTE (Check One)

Special Size Pet Grille (Hinge Door Grille) Order Form
Fax Number: 888-526-4329

DATE: _____

DEALER: _____

JOB NAME/PO#: _____

Completed by: _____

ESH (Hinge Door Grille) Standard Grille Height = 24-5/8"

Quantity _____

Color: White _____ Bronze _____ Mill Finish _____ Desert Sand _____ Champagne Beige _____

Special Paint (specify color) _____

HEIGHT _____
(used for grilles shorter than standard height)

Max height: 24" TAB-to-TAB

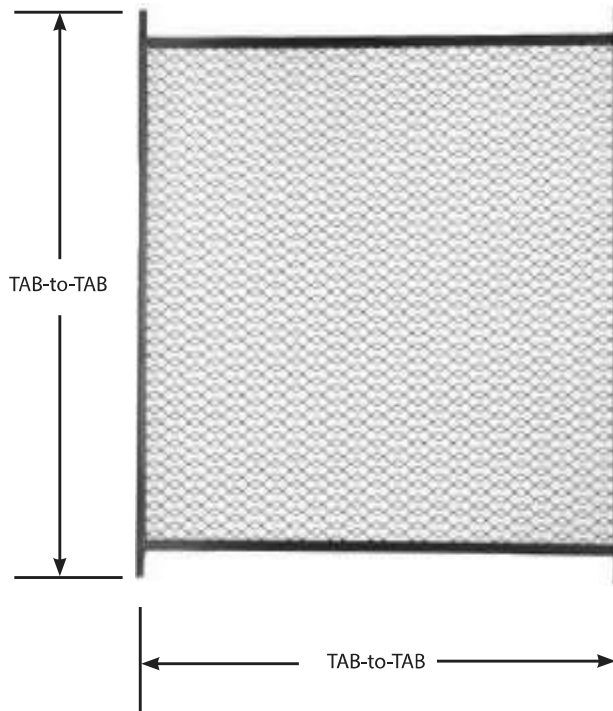

Special Size = Net Door Size minus 1" for TAB-to-TAB size

WIDTH _____

Example: Standard size ESHWH36 = 35" TAB-to-TAB width.
Actual Grille Size = W 30-3/8" x H 23-5/8" (without tabs).

Max width: 32-1/2" TAB-to-TAB



TRU-FRAME®
A name you can build on.

PART NO. DESCRIPTION SQUARE FEET PER ROLL

18 x 16 BRITE ALUMINUM WIRE Price per square foot--> (0.748)

PART NO.	DESCRIPTION	SQUARE FEET PER ROLL	Price per square foot-->	(0.748)
FAP18	Brite Aluminum Wire 18 x16 - 18"	150		\$112.20
FAP24	Brite Aluminum Wire 18 x16 - 24"	200		\$149.60
FAP28	Brite Aluminum Wire 18 x16 - 28"	233		\$174.53
FAP30	Brite Aluminum Wire 18 x16 - 30"	250		\$187.00
FAP32	Brite Aluminum Wire 18 x16 - 32"	267		\$199.47
FAP34	Brite Aluminum Wire 18 x16 - 34"	283		\$211.93
FAP36	Brite Aluminum Wire 18 x16 - 36"	300		\$224.40
FAP42	Brite Aluminum Wire 18 x16 - 42"	350		\$261.80
FAP48	Brite Aluminum Wire 18 x16 - 48"	400		\$299.20
				(0.807)
FAP60	Brite Aluminum Wire 18 x16 - 60"	500		\$403.50
FAP72	Brite Aluminum Wire 18 x16 - 72"	600		\$484.20

18 x 16 CHARCOAL ALUMINUM WIRE Price per square foot--> (0.797)

PART NO.	DESCRIPTION	SQUARE FEET PER ROLL	Price per square foot-->	(0.797)
FAP18CH	Charcoal Aluminum Wire 18 x16 - 18"	150		\$119.55
FAP24CH	Charcoal Aluminum Wire 18 x16 - 24"	200		\$159.40
FAP28CH	Charcoal Aluminum Wire 18 x16 - 28"	233		\$185.97
FAP30CH	Charcoal Aluminum Wire 18 x16 - 30"	250		\$199.25
FAP32CH	Charcoal Aluminum Wire 18 x16 - 32"	267		\$212.53
FAP34CH	Charcoal Aluminum Wire 18 x16 - 34"	283		\$225.82
FAP36CH	Charcoal Aluminum Wire 18 x16 - 36"	300		\$239.10
FAP42CH	Charcoal Aluminum Wire 18 x16 - 42"	350		\$278.95
FAP48CH	Charcoal Aluminum Wire 18 x16 - 48"	400		\$318.80
				(0.855)
FAP60CH	Charcoal Aluminum Wire 18 x16 - 60"	500		\$427.50
FAP72CH	Charcoal Aluminum Wire 18 x16 - 72"	600		\$513.00

18 x 14 BRONZE INSECT SCREEN Price per square foot--> (4.167)

PART NO.	DESCRIPTION	SQUARE FEET PER ROLL	Price per square foot-->	(4.167)
FBZ24	Bronze Insect Screen 24" x 100' RL	200		\$833.40
FBZ30	Bronze Insect Screen 30" x 100' RL	250		\$1041.75
FBZ36	Bronze Insect Screen 36" x 100' RL	300		\$1,250.10
FBZ48	Bronze Insect Screen 48" x 100' RL	400		\$1,666.80
FBZ60	Bronze Insect Screen 60" x 100' RL	500		\$2,083.50

NOTE: Bronze Insect Screen is made of 90% copper and 10% Zinc. Product will weather to a Dark Bronze finish.



PHIFER WIRE PRODUCTS, INC



TRU-FRAME®
A name you can build on.

PART NO.

DESCRIPTION

18 x 16 PHIFER CHARCOAL & GRAY FIBERGLASS **Roll Size / SQ. Ft Per Roll** **Price per square foot-->** **(0.365)**

PART NO.	DESCRIPTION	Roll Size / SQ. Ft Per Roll	Price per square foot-->	(0.365)
FF18CH, GR	Charcoal or Gray 18 x 16 Fiber	18" x 100' RL	150	\$54.75
FF20CH, GR	Charcoal or Gray 18 x 16 Fiber	20" x 100' RL	167	\$60.83
FF24CH, GR	Charcoal or Gray 18 x 16 Fiber	24" x 100' RL	200	\$73.00
FF26CH, GR	Charcoal or Gray 18 x 16 Fiber	26" x 100' RL	217	\$79.08
FF28CH, GR	Charcoal or Gray 18 x 16 Fiber	28" x 100' RL	233	\$85.17
FF30CH, GR	Charcoal or Gray 18 x 16 Fiber	30" x 100' RL	250	\$91.25
FF32CH, GR	Charcoal or Gray 18 x 16 Fiber	32" x 100' RL	267	\$97.33
FF34CH, GR	Charcoal or Gray 18 x 16 Fiber	34" x 100' RL	283	\$103.42
FF36CH, GR	Charcoal or Gray 18 x 16 Fiber	36" x 100' RL	300	\$109.50
FF38CH, GR	Charcoal or Gray 18 x 16 Fiber	38" x 100' RL	317	\$115.58
FF40CH, GR	Charcoal or Gray 18 x 16 Fiber	40" x 100' RL	333	\$121.67
FF42CH, GR	Charcoal or Gray 18 x 16 Fiber	42" x 100' RL	350	\$127.75
FF48CH, GR	Charcoal or Gray 18 x 16 Fiber	48" x 100' RL	400	\$146.00
FF54CH, GR	Charcoal or Gray 18 x 16 Fiber	54" x 100' RL	450	\$164.25
FF60CH, GR	Charcoal or Gray 18 x 16 Fiber	60" x 100' RL	500	\$182.50
FF72CH, GR	Charcoal or Gray 18 x 16 Fiber	72" x 100' RL	600	\$219.00
FF84CH, GR	Charcoal or Gray 18 x 16 Fiber	84" x 100' RL	700	\$255.50

18 x 14 CHARCOAL & GRAY FIBERGLASS

Roll Size / SQ. Ft Per Roll **Price per square foot-->**

(0.514)

PART NO.	DESCRIPTION	Roll Size / SQ. Ft Per Roll	Price per square foot-->	(0.514)
FFH24CH, GR	Charcoal or Gray 18 x 14 Fiber	24" x 100' RL	200	\$102.80
FFH30CH, GR	Charcoal or Gray 18 x 14 Fiber	30" x 100' RL	250	\$128.50
FFH36CH, GR	Charcoal or Gray 18 x 14 Fiber	36" x 100' RL	300	\$154.20
FFH48CH, GR	Charcoal or Gray 18 x 14 Fiber	48" x 100' RL	400	\$205.60
FFH60CH, GR	Charcoal or Gray 18 x 14 Fiber	60" x 100' RL	500	\$257.00
FFH72CH, GR	Charcoal or Gray 18 x 14 Fiber	72" x 100' RL	600	\$308.40
FFH84CH, GR	Charcoal or Gray 18 x 14 Fiber	84" x 100' RL	700	\$359.80

PHIFER PET SCREENING (100' Rolls)

Price per square foot--> **(1.216)**

PART NO.	DESCRIPTION	Roll Size / SQ. Ft Per Roll	Price per square foot-->	(1.216)
FPS36BL, GR	Pet Screen - 36"	300	\$364.80	
FPS48BL, GR	Pet Screen - 48"	400	\$486.40	
FPS60BL, GR	Pet Screen - 60"	500	\$608.00	



NOTE: Phifer Pet Screen is available in Black (BL) or Gray (GR).

PHIFER TUFFSCREEN (100' Rolls)

Price per square foot--> **(1.045)**

PART NO.	DESCRIPTION	Roll Size / SQ. Ft Per Roll	Price per square foot-->	(1.045)
FP36BL	Phifer Tuffscreen - 36"	300	\$313.50	
FP48BL	Phifer Tuffscreen - 48"	400	\$418.00	
FP60BL	Phifer Tuffscreen - 60"	500	\$522.50	
FP96BL	Phifer Tuffscreen - 96"	800	\$836.00	



NOTE: Phifer Tuffscreen only is available in Black (BL).



TRU-FRAME®
A name you can build on.

PART NO. DESCRIPTION SQUARE FEET PER ROLL

PHIFER 53 x 16 MESH SUNSCREEN (100' Rolls) Price per square foot--> (1.125)

PART NO.	DESCRIPTION	SQUARE FEET PER ROLL	PRICE PER SQUARE FOOT
FSS36CH, GR, BR	53 x 16 Mesh Sunscreen - 36"	300	\$337.50
FSS48CH, GR, BR	53 x 16 Mesh Sunscreen - 48"	400	\$450.00
FSS60CH, GR	53 x 16 Mesh Sunscreen - 60"	500	\$562.50
FSS72CH	53 x 16 Mesh Sunscreen - 72"	600	\$675.00
FSS84CH, GR, BR	53 x 16 Mesh Sunscreen - 84"	700	\$787.50

Call for pricing
on 50+ rolls

NOTE: Phifer Sunscreen is available in Charcoal (CH), Gray (GR), or Bronze (BR) in most sizes. Blocks up to 75% of the sun's heat.



PHIFER SUNTEX 80 (100' Rolls) Price per square foot--> (1.312)

PART NO.	DESCRIPTION	SQUARE FEET PER ROLL	PRICE PER SQUARE FOOT
FST36BL, BR, DB, GR, ST, BE	Suntex 80% - 36"	300	\$393.60
FST48BL, BR, DB, GR, ST, BE	Suntex 80% - 48"	400	\$524.80
FST60BL, BR, DB, GR, ST, BE	Suntex 80% - 60"	500	\$656.00
FST72BL, BR, DB, GR, ST, BE	Suntex 80% - 72"	600	\$787.20
FST96BL, BR, DB, GR, ST, BE	Suntex 80% - 96"	800	\$1,049.60

Call for pricing
on 50+ rolls

NOTE: Phifer Suntex 80 is available in Black (BL), Brown (BR), Dark Bronze (DB), Gray (GR), Stucco (ST), or Beige (BE) in most sizes. Blocks up to 80% of the sun's heat.



PHIFER SUNTEX 90 (100' Rolls) Price per square foot--> (1.691)

PART NO.	DESCRIPTION	SQUARE FEET PER ROLL	PRICE PER SQUARE FOOT
FSN36BL, BR, DB, GR, ST, BE	Suntex 90% - 36"	300	\$507.30
FSN48BL, BR, DB, GR, ST, BE	Suntex 90% - 48"	400	\$676.40
FSN60BL, BR, DB, GR, ST, BE	Suntex 90% - 60"	500	\$845.50
FSN72BL, BR, DB, GR, ST, BE	Suntex 90% - 72"	600	\$1,014.60
FSN96BL, BR, DB, GR, ST, BE	Suntex 90% - 96"	800	\$1,352.80

Call for pricing
on 50+ rolls

NOTE: Phifer Suntex 90 is available in Black (BL), Brown (BR), Dark Bronze (DB), Gray (GR), Stucco (ST), or Beige (BE). Blocks up to 90% of the sun's heat.



PHIFER SUNTEX 95 (90' Rolls) Price per square foot--> (2.257)

PART NO.	DESCRIPTION	SQUARE FEET PER ROLL	PRICE PER SQUARE FOOT
FSM126BL, WH, BR, MO, AL	Suntex 95% - 126" x 90' Only	945	\$2,132.87

NOTE: Phifer Suntex 95 is available in Black (BL), Dark Bronze (DB), White (WH), White/Gray (WG), Mocha (MO), or Alpaca (AL). Blocks up to 95% of the sun's heat.





TRU-FRAME®
A name you can build on.

PART NO. DESCRIPTION SQUARE FEET PER ROLL

PHIFER BETTERTVUE® SCREENING (100' Rolls) Price per square foot--> (.430)

Part No.	Description	Sq Ft Per Roll	Price
FBV24CH	Phifer BetterVue® Screen - 24"	200	\$86.00
FBV36CH	Phifer BetterVue® Screen - 36"	300	\$129.00
FBV48CH	Phifer BetterVue® Screen - 48"	400	\$172.00
FBV60CH	Phifer BetterVue® Screen - 60"	500	\$215.00
FBV72CH	Phifer BetterVue® Screen - 72"	600	\$258.00



NOTE: Phifer BetterVue® is available in Black (CH)

PHIFER ULTRAVUE® SCREENING (100' Rolls) Price per square foot--> (0714)

Part No.	Description	Sq Ft Per Roll	Price
FUV24BL	Phifer UltraVue® Screen - 24"	200	\$142.80
FUV36BL	Phifer UltraVue® Screen - 36"	300	\$214.20
FUV48BL	Phifer UltraVue® Screen - 48"	400	\$285.60
FUV60BL	Phifer UltraVue® Screen - 60"	500	\$357.00
FUV72BL	Phifer UltraVue® Screen - 72"	600	\$428.40



NOTE: Phifer UltraVue® is available in Black (BL)

PHIFER 20x30 SOLAR INSECT SCREENING (100' Rolls) Price per square foot--> (1.163)

Part No.	Description	Sq Ft Per Roll	Price
FSB36CH, GR	20 x 30 Mesh Sunscreen - 36"	300	\$348.90
FSB48CH, GR	20 x 30 Mesh Sunscreen - 48"	400	\$465.20
FSB60CH, GR	20 x 30 Mesh Sunscreen - 60"	500	\$581.50
FSB72CH, GR	20 x 30 Mesh Sunscreen - 72"	600	\$697.80
FSB84CH, GR	20 x 30 Mesh Sunscreen - 84"	700	\$814.10



**NOTE: Phifer Solar Insect Screening is available in Charcoal (CH) or Gray (GR).
Blocks up to 65% of the sun's heat.**

PHIFER SUPER SOLAR PLUS SCREENING (100' Rolls) Price per square foot--> (1.743)

Part No.	Description	Sq Ft Per Roll	Price
FSL36CH	Phifer Super Solar Plus - 36"	300	\$522.90
FSL48CH	Phifer Super Solar Plus - 48"	400	\$697.20
FSL60CH, GR	Phifer Super Solar Plus - 60"	500	\$871.50
FSL84CH	Phifer Super Solar Plus - 84"	700	\$1,220.10



**NOTE: Phifer Super Solar Plus Screening is available in Charcoal (CH) or Gray (GR) in most sizes.
Blocks up to 90% of the sun's heat.**

GLASSINE CLEAR PLASTIC GAUGE YARDS SQ FT PER ROLL

Part No.	Description	Gauge	Yards	Sq Ft Per Roll	Price
FGP48	Glassine Clear Plastic - 48"	0.012	52	624	\$517.30
FGP54	Glassine Clear Plastic - 54"	0.012	47	635	\$526.42
FGPH36	Glassine Clear Plastic - 36"	0.016	60	540	\$521.10
FGPH48	Glassine Clear Plastic - 48"	0.016	45	540	\$521.10
FGPH54	Glassine Clear Plastic - 54"	0.016	40	540	\$521.10



TRU-FRAME®
A name you can build on.

PART NO. DESCRIPTION SQUARE FEET PER ROLL

PHIFER NO-SEE-UMS 20X20 MESH (100' Rolls) Price per square foot--> (1.131)

PART NO.	DESCRIPTION	SQUARE FEET PER ROLL	PRICE
FNSU36CH	20x20 Fiberglass Screen Mesh - 36"	300	\$339.30
FNSU48CH	20x20 Fiberglass Screen Mesh - 48"	400	\$452.40
FNSU60CH	20x20 Fiberglass Screen Mesh - 60"	500	\$565.50
FNSU72CH	20x20 Fiberglass Screen Mesh - 72"	600	\$678.60



NO-SEE-UMS is available in Charcoal or Silver Gray

PHIFER SeeVue® Stainless Insect Screen (100' Rolls) Price per square foot--> (3.303)

PART NO.	DESCRIPTION	SQUARE FEET PER ROLL	PRICE
FSV36CH	Stainless Steel Screen Mesh - 36"	300	\$990.90
FSV48CH	Stainless Steel Screen Mesh - 48"	400	\$1,321.20
FSV60CH	Stainless Steel Screen Mesh - 60"	500	\$1,651.50



SeeVue® Stainless Steel Insect Screening is only available in Black (CH)

R.O.M. Rolls

18x16 Fiberglass R.O.M. Rolls Price per square foot--> (0.244)

PART NO.	DESCRIPTION	ROLL SIZE	SQ. FT PER ROLL	PRICE
FTF18CHS, GRS	ROM Charcoal or Gray 18 x 16 Fiber	18" x 600' RL	900	\$219.60
FTF24CHS, GRS	ROM Charcoal or Gray 18 x 16 Fiber	24" x 600' RL	1200	\$292.80
FTF30CHS, GRS	ROM Charcoal or Gray 18 x 16 Fiber	30" x 600' RL	1500	\$366.00
FTF36CHS, GRS	ROM Charcoal or Gray 18 x 16 Fiber	36" x 600' RL	1800	\$439.20
FTF48CHS, GRS	ROM Charcoal or Gray 18 x 16 Fiber	48" x 600' RL	2400	\$585.60
FTF60CHS, GRS	ROM Charcoal or Gray 18 x 16 Fiber	60" x 600' RL	3000	\$732.00
FTF72CHS, GRS	ROM Charcoal or Gray 18 x 16 Fiber	72" x 600' RL	3600	\$878.40

PHIFER BETTERTVUE® R.O.M. Rolls (600' Rolls) Price per square foot--> (0.297)

PART NO.	DESCRIPTION	SQUARE FEET PER ROLL	PRICE
FBV24CHS	Phifer BetterVue® Screen - 24"	1200	\$356.40
FBV36CHS	Phifer BetterVue® Screen - 36"	1800	\$534.60
FBV48CHS	Phifer BetterVue® Screen - 48"	2400	\$712.80
FBV60CHS	Phifer BetterVue® Screen - 60"	3000	\$891.00



R.O.M. Rolls

NOTE: Phifer BetterVue® is only available in Black (CH)

PHIFER ULTRAVUE® R.O.M. Rolls (300' Rolls) Price per square foot--> (0.714)

PART NO.	DESCRIPTION	SQUARE FEET PER ROLL	PRICE
FUV24BLS	Phifer UltraVue® Screen - 24"	600	\$428.40
FUV36BLS	Phifer UltraVue® Screen - 36"	900	\$642.60
FUV48BLS	Phifer UltraVue® Screen - 48"	1200	\$856.80
FUV60BLS	Phifer UltraVue® Screen - 60"	1500	\$1,071.00
FUV72BLS	Phifer UltraVue® Screen - 72"	1800	\$1,285.20



R.O.M. Rolls

NOTE: Phifer UltraVue® is only available in Black (BL)



TRU-FRAME®
A name you can build on.

VINYL SERRATED SPLINE

ITEM	DIAMETER	COLOR	15lb Spool FT. Per Spool	PRICE
FVS120	0.120	Gray/Black	2925	\$90.00
FVS135	0.135	Gray/Black	2190	\$90.00
FVS145	0.145	Gray/Black	1860	\$90.00
FVS155	0.155	Gray/Black	1710	\$90.00
FVS160	0.160	Gray/Black	1605	\$90.00
FVS165	0.165	Gray/Black	1500	\$90.00
FVS175	0.175	Gray/Black	1320	\$90.00
FVS180	0.180	Gray/Black	1200	\$90.00
FVS185	0.185	Gray/Black	1140	\$90.00
FVS190	0.190	Gray/Black	1095	\$90.00
FVS195	0.195	Gray/Black	1005	\$90.00
FVS200	0.200	Gray/Black	990	\$90.00
FVS205	0.205	Gray/Black	960	\$90.00
FVS210	0.210	Gray/Black	915	\$90.00
FVS220	0.220	Gray/Black	855	\$90.00
FVS225	0.225	Gray/Black	810	\$90.00
FVS235	0.235	Gray/Black	750	\$90.00
FVS245	0.245	Gray/Black	690	\$90.00

SPLINE SIZE CHART

Item Desc.	Dimensions	18 x 16	Alum	Suntex	Pet Screen
A102 Promo	2" x 5/8" RollForm Screen Door Frame	FVS220			
A134 Sequoia	2" x 5/8" RollForm Screen Door Frame	FVS210	FVS205		
A2** Screen (all)	2" x 3/4" Extruded Screen Door Frame	FVS220	FVS210	FVS210	FVS210
C514 Security	3" x 1" Extruded Security Door Frame	FVS210	FVS210	FVS210	FVS210
D100 Patio	1 5/8" x 1/2" RollForm Steel Patio Frame	FVS165	FVS165	FVS155	FVS155
D150 Patio	1 3/4" x 1/2" RollForm Aluminum Patio Frame	FVS195	FVS195	FVS185	FVS185
D200/250/275 Patio	1 7/8" x 1/2" Extruded Patio Slider Frame	FVS210	FVS210	FVS210	FVS210
D350 Primacy	2 1/2" x 17/32" Extruded Patio Slider Frame	FVS210	FVS210	FVS210	FVS210
D500 Legacy	2 1/4" x 1" Extruded Patio Slider Frame	FVS210	FVS210	FVS210	FVS210
G1120, G1130	1" x 7/16" RollForm Aluminum Screen Frame	FVS220	FVS220	FVS220	FVS220
G1150, G1160	7/16" x 3/4" RollForm Aluminum Screen Frame	FVS175	FVS175	FVS175	FVS175
G1170, G1180	5/16" & 1/2" RollForm Aluminum Screen Frame	FVS175	FVS175	FVS175	FVS175
G1190, G1195	3/8" x 3/4" RollForm Aluminum Screen Frame	FVS175	FVS175	FVS175	FVS175
G1200	5/16" x 3/4" RollForm Aluminum Screen Frame	FVS175	FVS175	FVS175	FVS175
G1230	1/4" x 3/4" RollForm Aluminum Screen Frame	FVS135	FVS135	FVS135	FVS135
G1240	3/4" Standoff RollForm Aluminum Screen Frame	FVS175	FVS175	FVS175	FVS175
G2130	1" x 3/8" Extruded Aluminum Screen Frame	FVS195	FVS195	FVS175	FVS175

SUGGESTED SPLINE SIZES ONLY: The spline sizes above are those used internally to manufacture Tru-Frame® Company products. The 'correct' amount of screen tension is subjective and preferences vary. These are offered as suggestions only, your mileage may vary.



TRU-FRAME®
A name you can build on.

PHIFER INTERIOR SUN CONTROL FABRICS

PART NO.	DESCRIPTION	SQUARE FEET PER ROLL	
PHIFER SheerWeave® 1000		Price per square foot-->	(1.755)
FSS36WHA, WHB	SheerWeave 1000 - 36"	270	\$473.85
FSS48WHA, WHB	SheerWeave 1000 - 48"	360	\$631.80
FSS72WHA,WHB	SheerWeave 1000 - 72"	540	\$947.70

Standard Colors - Antique White (WHA) and Brite White (WHB).
Phifer SheerWeave® 1000 products are recommended for use in interior applications only.

PHIFER SheerWeave® Style 2000/2100

SheerWeave 2000/210072" x 30 Lineal Yard Roll
SheerWeave 2000/210096" x 30 Lineal Yard Roll
UV Blockage:.....Style 2000: 95%, Style 2100: 90%

PHIFER SheerWeave® Style 3000

SheerWeave 3000.....72" x 30 Lineal Yard Roll
UV Blockage:.....Style 3000: 86%

PHIFER SheerWeave® Style 4000/4100/4400

SheerWeave 4000/4100/440063" x 30 Lineal Yard Roll
SheerWeave 4000/4100/440084" x 30 Lineal Yard Roll
UV Blockage:.....Style 4000: 95%, Style 4100: 90%, Style 4400: 97%

PHIFER SheerWeave® Style 4800

SheerWeave 4800.....78" x 30 Lineal Yard Roll
UV Blockage:.....Style 4800: 99%

**ALL ITEMS IN THIS SECTION
ARE AVAILABLE THROUGH
SPECIAL ORDER ONLY.
CUSTOMERS MUST
PURCHASE FULL ROLL**

**All Phifer SheerWeave® products are recommended for use in interior applications only. Available in a variety of colors.
Call your customer service representative for more information and fabric samples. Full roll purchase only.**

DESIGNER FABRICS by PHIFER

PHIFERTEX® SOLIDS

Phifertex® Solids54" x 60 Lineal Yard Roll

PHIFERTEX® PLUS

Phifertex® Plus54" x 60 Lineal Yard Roll

**Durable fabrics designed to capture your distinctive life-style. Available in a variety of colors and designs.
Call your customer service representative for more information and fabric samples.**





SCREEN FRAME

TRU-FRAME®
A name you can build on.

	FINISH	PRICE PER FOOT	PRICE PER BOX	10 PC BUNDLE PRICE		FINISH	PRICE PER FOOT	PRICE PER BOX	10 PC BUNDLE PRICE
	G1130 - 1" x 7/16" SCREEN FRAME - .025					GHG1130 - 1" x 7/16" SCREEN FRAME - .025			
	MF	\$1.299	\$1,327.58	\$181.74		MF	\$1.260	\$1,287.72	\$176.28
	##	\$1.504	\$1,537.09	\$210.47		##	\$1.407	\$1,437.95	\$196.82
Use corner GC112					Use corner GCHG112				
Pieces per box: 84 Feet per box: 1022' Individual piece length: 12' 2" ## - Finishes: Almond (□), Bronze (■), Gray (□), Tan (□), and White (□)					Pieces per box: 84 Feet per box: 1022' Individual piece length: 12' 2" ## - Finishes: Almond (□), Bronze (■), Gray (□), Tan (□), and White (□)				
	G1160 - 3/4" x 7/16" SCREEN FRAME - .020					GHG1160 - 3/4" x 7/16" SCREEN FRAME - .020			
	MF	\$0.849	\$1,033.23	\$118.75		MF	\$0.857	\$1,042.97	\$119.86
	##	\$0.985	\$1,198.75	\$137.93		##	\$0.956	\$1,163.45	\$133.64
Use corner GC115, GC127					Use corner GCHG115				
Pieces per box: 100 Feet per box: 1217' Individual piece length: 12' 2" ## - Finishes: Almond (□), Bronze (■), Gray (□), Tan (□), and White (□)					Pieces per box: 100 Feet per box: 1217' Individual piece length: 12' 2" ## - Finishes: Bronze (■), White (□), and Mill Finish (▨)				
	G1190 - 3/4" x 3/8" SCREEN FRAME - .020					GHG1190 - 3/4" x 3/8" SCREEN FRAME - .020			
	MF	\$0.828	\$1,259.39	\$115.83		MF	\$0.805	\$1,224.41	\$112.58
	##	\$0.964	\$1,466.24	\$134.87		##	\$0.901	\$1,370.42	\$126.10
Use corner GC119, GC128					Use corner GCHG119				
Pieces per box: 125 Feet per box: 1521' Individual piece length: 12' 2" ## - Finishes: Almond (□), Bronze (■), Gray (□), Tan (□), and White (□)					Pieces per box: 125 Feet per box: 1521' Individual piece length: 12' 2" ## - Finishes: Bronze (■), White (□), and Mill Finish (▨)				
	G1200 - 3/4" x 5/16" SCREEN FRAME - .020					GHG1200 - 3/4" x 5/16" SCREEN FRAME - .020			
	MF	\$0.806	\$1,225.93	\$112.71		MF	\$0.781	\$1,187.90	\$109.33
	##	\$0.938	\$1,426.70	\$131.22		##	\$0.875	\$1,330.88	\$122.46
Use corner GC120, GC129					Use corner GCHG120				
Pieces per box: 125 Feet per box: 1521' Individual piece length: 12' 2" ## - Finishes: Almond (□), Bronze (■), Gray (□), Tan (□), and White (□)					Pieces per box: 125 Feet per box: 1521' Individual piece length: 12' 2" ## - Finishes: Bronze (■), White (□), and Mill Finish (▨)				

All screen frame is sold in 10 piece bundles or full cartons only.



TRU-FRAME®
A name you can build on.

SECTION G

FINISH	PRICE PER FOOT	PRICE PER BOX	10 PC BUNDLE PRICE
G1150 - 3/4" x 7/16" SCREEN FRAME - .025			
MF	\$1.109	\$1,349.65	\$155.13
##	\$1.282	\$1,560.19	\$179.40
Use corner GC115, GC127			

Pieces per box: 100
Feet per box: 1217'
Individual piece length: 12'2"
- Finishes: Bronze (■), Gray (■), White (□)

FINISH	PRICE PER FOOT	PRICE PER BOX	10 PC BUNDLE PRICE
G1195 - 3/4" x 3/8" SCREEN FRAME - .025			
MF	\$1.114	\$1,694.39	\$155.88
##	\$1.282	\$1,949.92	\$179.40
Use corner GC119, GC128			

Pieces per box: 125
Feet per box: 1521'
Individual piece length: 12'2"
- Finishes: Bronze (■), Gray (■), White (□), Almond (■)

FINISH	PRICE PER FOOT	PRICE PER BOX	10 PC BUNDLE PRICE
G1120 - 1" x 7/16" SCREEN FRAME - .032			
MF	\$1.676	\$1,712.87	\$234.50
##	\$1.959	\$2,002.10	\$274.17
Use corner GC112			

Pieces per box: 84
Feet per box: 1022'
Individual piece length: 12'2"
- Finishes: Bronze (■), Gray (■), Tan (■), White (□)

FINISH	PRICE PER FOOT	PRICE PER BOX	10 PC BUNDLE PRICE
G1220 - 1" x 5/16" SCREEN FRAME - .025			
##	\$1.373	\$1,403.21	\$192.14
Use corner GC121			

Pieces per box: 84
Feet per box: 1022'
Individual piece length: 12'2"
- Finishes: Almond (■), Bronze (■), Tan (■), White (□)

FINISH	PRICE PER FOOT	PRICE PER BOX	10 PC BUNDLE PRICE
G1180 - 1/2" LIP FRAME - .025			
MF	\$1.596	\$1,631.11	\$223.34
##	\$1.777	\$1,816.09	\$248.69
Use corner GC115			

Pieces per box: 84
Feet per box: 1022'
Individual piece length: 12'2"
- Finishes: Almond (■), Bronze (■), Gray (■), and White (□)

FINISH	PRICE PER FOOT	PRICE PER BOX	10 PC BUNDLE PRICE
G1230 - 3/4" x 1/4" SCREEN FRAME - .020			
MF	\$1.035	\$1,259.60	\$144.88
##	\$1.136	\$1,382.51	\$159.00
Use corner GC123			

Pieces per box: 100
Feet per box: 1217'
Individual piece length: 12'2"
- Finishes: Bronze (■) and White (□)

FINISH	PRICE PER FOOT	PRICE PER BOX	10 PC BUNDLE PRICE
G1270 - 7/8" SPREADER BAR - .030			
MF	\$1.242	\$1,117.80	\$173.68
##	\$1.359	\$1,223.10	\$190.06
Use clip G159			

Pieces per box: 75
Feet per box: 900'
Individual piece length: 12'0"
- Finishes: Almond (■), Bronze (■), Gray (■), White (□), & Tan (■)

FINISH	PRICE PER FOOT	PRICE PER BOX	10 PC BUNDLE PRICE
G1280 - 5/16" SPREADER BAR - .025			
MF	\$0.919	\$1,102.80	\$128.57
##	\$0.997	\$1,196.40	\$139.49
Use clip G160			

Pieces per box: 100
Feet per box: 1200'
Individual piece length: 12'0"
- Finishes: Bronze (■), Gray (■), and White (□)

FINISH	PRICE PER FOOT	PRICE PER BOX	10 PC BUNDLE PRICE
G1240 - 3/4" STAND-OFF FRAME			
MF	\$1.703	\$1,864.79	\$238.20
##	\$1.980	\$2,168.10	\$277.00
Use corner GC115			

Pieces per box: 90
Feet per box: 1095'
Individual piece length: 12'2"
- Finishes: Bronze (■), White (□), Almond (■), Gray (■), & Tan (■)

FINISH	PRICE PER FOOT	PRICE PER BOX	10 PC BUNDLE PRICE
GHG1240 - 3/4" STAND-OFF FRAME			
MF	\$1.681	\$1,638.98	\$251.29
##	\$1.875	\$1,828.13	\$280.28
Use corner GCHG115			

Pieces per box: 75
Feet per box: 975'
Individual piece length: 13'
- Finishes: Bronze (■), White (□)



EXTRUDED FRAME

R. Lang Company SECTION G

TRU-FRAME®
A name you can build on.

FINISH	PRICE PER FOOT	PRICE PER BOX	10 PC BUNDLE PRICE
G1390 - 3/4" EXTRUDED CHANNEL - .045			
SA	\$4.188	\$1,273.00	\$587.60
BR	\$3.631	\$1,103.93	\$509.50

Pieces per box: 25
Feet per box: 304'
Individual piece length: 12' 2"
Finishes: Satin Anodized (SA) and Bronze Paint (BR)

FINISH	PRICE PER FOOT	PRICE PER BOX	10 PC BUNDLE PRICE
G1300 - 7/16" EXTRUDED H SECTION - .045			
SA	\$3.209	\$1,925.40	\$442.00
##	\$2.579	\$1,547.40	\$343.20

Pieces per box: 50
Feet per box: 600'
Individual piece length: 12' 0"
Finishes: White (SA), Bronze (BR) and Tan (##)

FINISH	PRICE PER FOOT	PRICE PER BOX	10 PC BUNDLE PRICE
G2130 - 1" x 3/8" EXTRUDED FRAME - .050			
MF	\$2.697	\$819.89	\$377.38
SA	\$3.594	\$1,092.58	\$502.88
BA	\$3.594	\$1,092.58	\$502.88
WH	\$3.368	\$1,023.87	\$471.25

Use corner GC212

Pieces per box: 25
Feet per box: 304'
Individual piece length: 12' 2"
Finishes: Mill (MF), Satin Anodized (SA), Bronze Anodized (BA), and White (WH)

G1246 - 1 1/8" x 13/16" EXT FRAME - .050			
BA	\$52.25		
##	\$41.12		

(Price each)

Pieces per box: N/A sold as one length
Individual piece length: 12' 4"
Finishes ##: CB and White

G1310 - 7/16" "F" CHANNEL - .045			
MF	\$34.44		
SA	\$43.11		
##	\$65.73		

(Price each)

Pieces per box: N/A sold as one length
Individual piece length: 12' 2"
- Finishes: Bronze (BR), White Paint (WH) and Almond (##)

G1170 - 5/16" LIP FRAME - .020			
WH	\$1.434	\$2,093.64	\$200.59

Use corner GC125

Pieces per box: 120
Feet per box: 1460'
Individual piece length: 12' 2"
Available only in White Finish (WH)

G1330 - 1" x 1" EXTRUDED ANGLE - .050			
MF	\$41.16		
SA	\$65.91		
BR	\$56.25		
WH	\$56.25		

(Price each)





Pieces per box: N/A sold as one length
Individual piece length: 12' 0"
Finishes: Mill (MF), Satin Anodized (SA), Bronze Anodized (BA), and White (WH)

**Unless otherwise noted:
All screen frame is sold in 10 piece bundles or full cartons only.**

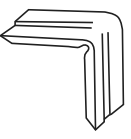
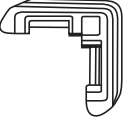
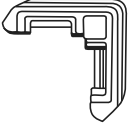

TRU-FRAME®
A name you can build on.

SECTION G

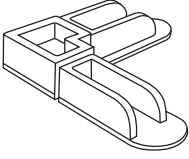
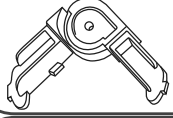
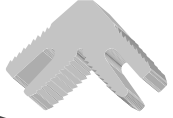
	PART NO.	DESCRIPTION	FINISH	UNIT PRICE EACH		BOX PRICE	
	1" x 7/16" INSIDE CORNER			100	1000	100	1000
	GC112	1" x 7/16" x .060 Inside Corner	Mill	\$0.600	\$0.552	\$60.00	\$552.00
	GC112L	1" x 7/16" x .050 Inside Corner	Mill	\$0.477	\$0.439	\$47.70	\$439.00
	GCHG112	1" x 7/16" x .060 Inside Corner (Generic)	Mill	\$0.558	\$0.513	\$55.80	\$513.00
	3/4" x 7/16" INSIDE CORNER						
	GC115	3/4" x 7/16" x .040 Inside Corner	Mill	\$0.324	\$0.298	\$32.40	\$298.00
	GC115H	3/4" x 7/16" x .050 Inside Corner	Mill	\$0.363	\$0.334	\$36.30	\$334.00
	GC115XL	3/4" x 7/16" x .060 Inside Corner	Mill	\$0.475	\$0.437	\$47.50	\$437.00
	GCHG115	3/4" x 7/16" x .040 Inside Corner (Generic)	Mill	\$0.302	\$0.278	\$30.20	\$278.00
	3/4" x 3/8" INSIDE CORNER						
	GC119	3/4" x 3/8" x .040 Inside Corner	Mill	\$0.285	\$0.262	\$28.50	\$262.00
	GC119H	3/4" x 3/8" x .050 Inside Corner	Mill	\$0.369	\$0.339	\$36.90	\$339.00
	GCHG119	3/4" x 3/8" x .040 Inside Corner (Generic)	Mill	\$0.265	\$0.244	\$26.50	\$244.00
	3/4" x 5/16" INSIDE CORNER						
	GC120	3/4" x 5/16" x .040 Inside Corner	Mill	\$0.276	\$0.254	\$27.60	\$254.00
	GCHG120	3/4" x 5/16" x .040 Inside Corner (Generic)	Mill	\$0.258	\$0.237	\$25.80	\$237.00
	1" x 5/16" INSIDE CORNER						
	GC121	1" x 5/16" Inside Corner	Mill	\$0.365	\$0.336	\$36.50	\$336.00
	3/4" x 1/4" INSIDE CORNER						
	GC123	3/4" x 1/4" x .040 Inside Corner	Mill	\$0.258	\$0.237	\$25.80	\$237.00
	5/8" x 3/8" INSIDE CORNER						
	GC125	5/8" x 3/8" Inside Corner	Mill	\$0.313	\$0.288	\$31.30	\$288.00
	OUTSIDE PLASTIC CORNER						
	GC127	3/4" x 7/16" Plastic Corner *Almond, Bronze, Gray or White	Any*	\$0.460	\$0.423	\$46.00	\$423.00
	GC128	3/4" x 3/8" Plastic Corner *Almond, Bronze, Gray or White	Any*	\$0.386	\$0.355	\$38.60	\$355.00
	GC129	3/4" x 5/16" Plastic Corner *Almond, Bronze, Gray or White	Any*	\$0.363	\$0.334	\$36.30	\$334.00
	GC132	1" x 7/16" Plastic Corner *Almond, Bronze, Gray, Tan or White	Any*	\$0.647	\$0.595	\$64.70	\$595.00
	1" ADJUSTABLE CORNER						
	GC133	1" Adjustable Plastic Corner *Almond, Bronze, Gray, Tan or White	Any*	\$0.994	\$0.914	\$99.40	\$914.00
	1" EXTRUDED CORNERS						
	GC212	1" x 3/8" Extruded Corner	Mill	\$1.278	\$1.176	\$127.80	\$1176.00
	GC216	1" x 7/16" Extruded Corner	Mill	\$1.420	\$1.306	\$142.00	\$1306.00



TRU-FRAME®
A name you can build on.



	PART NO.	DESCRIPTION	FINISH	UNIT PRICE EACH		BOX PRICE	
	SINGLE JIFFY PAKS						
	G146MF	Single Jiffy Paks	Mill	\$2.033	\$1.870	\$203.30	\$1,870.00
	G146##	Single Jiffy Paks ## - Gray (GR), Bronze (BR) or White (WH)	Any*	\$2.604	\$2.396	\$260.40	\$2,396.00
	Contents: (1) Bail Latch with Screw, (1) Pair Jiffy Hangers with Nails						
	DOUBLE JIFFY PAKS						
	G147MF	Double Jiffy Paks	Mill	\$2.674	\$2.460	\$267.40	\$2,460.00
	G147##	Double Jiffy Paks ## - Gray (GR), Bronze (BR) or White (WH)	Any*	\$3.046	\$2.802	\$304.60	\$2,802.00
	Contents: (2) Bail Latches with (2) Screws, (1) Pair Jiffy Hangers with Nails						
	FLAT WINDOW SPRINGS						
	G150	3-1/2" Flat Window Springs	Mill	\$0.492	\$0.453	\$49.20	\$453.00
	CORNER LEAF SPRINGS						
	G151	Corner Leaf Springs - Standard	Mill	\$0.260	\$0.239	\$26.00	\$239.00
	G151WD	Corner Leaf Springs - Wide & Tall	Mill	\$0.262	\$0.241	\$26.20	\$241.00
	LIFT CLIPS						
	G152MF	3/4" Lift Clips	Mill	\$0.246	\$0.226	\$24.60	\$226.00
	PULL TABS						
	G153##	Nylon Pull Tabs ## - Almond (□), Black (■), Gray (□), White (□)	Any*	\$0.204	\$0.188	\$20.40	\$188.00
	LOOP PULL TABS						
	G154BL	Nylon Loop Pull Tabs	Black	\$0.270	\$0.248	\$27.00	\$248.00
	G154WH	Nylon Loop Pull Tabs	White	\$0.270	\$0.248	\$27.00	\$248.00

All screen frame components sold in increments of 100 or 1000 only. No exceptions.

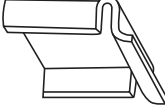
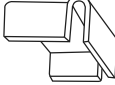
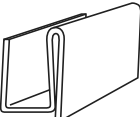

TRU-FRAME®
A name you can build on.

SECTION G

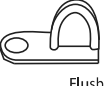
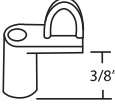
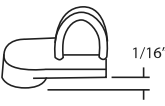
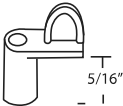
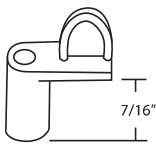
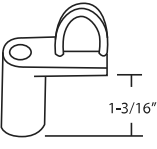
	PART NO.	DESCRIPTION	FINISH	UNIT PRICE EACH		BOX PRICE	
	7/8" SPREADER BAR CLIPS			100	1000	100	1000
	G159MF	7/8" Spreader Bar Clips	Mill	\$0.200	\$0.184	\$20.00	\$184.00
	5/8" SPREADER BAR CLIPS						
	G160MF	5/8" Spreader Bar Clips	Mill	\$0.193	\$0.178	\$19.30	\$178.00
	METAL RETAINER CLIP						
	G164	3/8" Metal Retainer Clip	Mill	\$0.670	\$0.616	\$67.00	\$616.00
	G165	7/16" Metal Retainer Clip	Mill	\$0.722	\$0.664	\$72.20	\$664.00
	PLASTIC RETAINER CLIP						
	G169	7/16" Plastic Retainer Clip	Gray	\$0.552	\$0.508	\$55.20	\$508.00
	DIE CAST WINDOW SCREEN CLIPS						
	G1661MF	Flush Mount Die cast Screen Clips	Mill	\$0.262	\$0.241	\$26.20	\$241.00
	G1661##	Flush Mount Die cast Screen Clips	##	\$0.292	\$0.269	\$29.20	\$269.00
	## Finishes Available: Almond, Bronze, Champagne Beige, White						
	G1662MF	3/8" Die cast Window Screen Clips	Mill	\$0.392	\$0.361	\$39.20	\$361.00
	G1662##	3/8" Die cast Window Screen Clips	##	\$0.436	\$0.401	\$43.60	\$401.00
	## Finishes Available: Almond, Black, Bronze, Champagne Beige, White						
	G1666MF	1/16" Die cast Window Screen Clips	Mill	\$0.316	\$0.291	\$31.60	\$291.00
	G1666##	1/16" Die cast Window Screen Clips	##	\$0.350	\$0.322	\$35.00	\$322.00
	G1667MF	5/16" Die cast Window Screen Clips	Mill	\$0.340	\$0.313	\$34.00	\$313.00
	G1667##	5/16" Die cast Window Screen Clips	##	\$0.377	\$0.347	\$37.70	\$347.00
	## Finishes Available: Black, Champagne Beige, White						
	G1668MF	7/16" Die cast Window Screen Clips	Mill	\$0.392	\$0.361	\$39.20	\$361.00
	G1668##	7/16" Die cast Window Screen Clips	##	\$0.436	\$0.401	\$43.60	\$401.00
	## Finishes Available: Almond, Black, Bronze, Champagne Beige, White						
	G1669MF	1-3/16" Die cast Window Screen Clips	Mill	\$0.602	\$0.554	\$60.20	\$554.00
	G1669##	1-3/16" Die cast Window Screen Clips	##	\$0.669	\$0.615	\$66.90	\$615.00
	## Finishes Available: Almond, Black, Bronze, Champagne Beige, White						
	NOTE: See Section M for pricing on screws for parts G1661 through G1669.						



TRU-FRAME®
A name you can build on.

	PART NO.	DESCRIPTION	FINISH	UNIT PRICE EACH		BOX PRICE	
	WIRE WINDOW SPRING						
	G175	Wire Window Springs		\$0.200	\$0.184	\$20.00	\$184.00
	RIVET ON SECURITY LATCH (PAIR)						
	G176	Rivet On Security Latch (Left & Right pair)	Mill	\$1.384	\$1.273	\$138.40	\$1,273.00
	NYLON PLUNGER LATCH						
	G177	Nylon Plunger Latch	Nylon	\$0.629	\$0.579	\$62.90	\$579.00
	ALUMINUM PLUNGER LATCH						
	G178	3/4" Aluminum Plunger Latch	Mill	\$1.260	\$1.159	\$126.00	\$1159.00
	G178S	Plunger Spring	Mill	\$0.149	\$0.137	\$14.90	\$137.00
	G179	1" Aluminum Plunger Latch	Mill	\$1.286	\$1.183	\$128.60	\$1183.00
	CASEMENT CLIPS						
	G180	3/8" Casement Clips (No Screws)	Mill	\$0.425	\$0.391	\$42.50	\$391.00
	G181	7/16" Casement Clips (No Screws)	Mill	\$0.425	\$0.391	\$42.50	\$391.00
	G182	7/16" Casement Clips (w/ Screws)	Mill	\$1.231	\$1.133	\$123.10	\$1,133.00
	SLIDE LOCKS						
	G161	3/4" Slide Locks	Mill	\$0.424	\$0.390	\$42.40	\$390.00
	METAL LOCK PINS						
	G157	1" Metal Lock Pins	Mill	\$0.486	\$0.447	\$48.60	\$447.00
	G158	3/4" Metal Lock Pins	Mill	\$0.526	\$0.484	\$52.60	\$484.00

All screen clips subject to a MINIMUM order of 100 each.

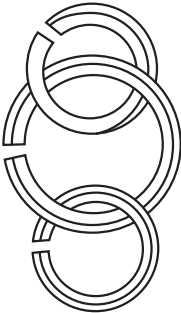





	PART NO.	DESCRIPTION	FINISH	PKG. QTY.	PRICE EACH
	SCREEN FRAME CIRCLE				
	G1850	1" Screen Frame Circle — 24" Diameter	Any*	1	\$33.00
	G1851	1" Screen Frame Circle — 30" Diameter	Any*	1	\$47.500
	G1852	1" Screen Frame Circle — 36" Diameter	Any*	1	\$57.000
	G1853	1" Screen Frame Circle — 42" Diameter	Any*	1	\$66.500
	G1854	1" Screen Frame Circle — 48" Diameter	Any*	1	\$76.000
	G1855	1" Screen Frame Circle — 60" Diameter	Any*	1	\$95.000
	G1856	1" Screen Frame Circle — 72" Diameter	Any*	1	\$114.00
	G1857	1" Screen Frame Circle — 96" Diameter	Any*	1	\$132.00

*Bronze or White Finish

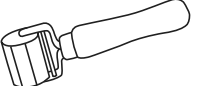

TRU-FRAME®
A name you can build on.

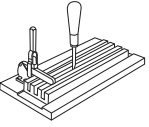
SECTION G

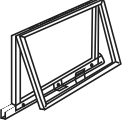
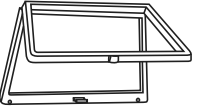
PART NO.	DESCRIPTION	FINISH	PKG. QTY.	PRICE EACH
COMBINATION ROLLER				
 G3010	Combination Roller <i>For installing both screen and spline to screen frame. Features both convex and concave ends.</i>	Steel	1	\$49.500
G3016	1/16" Replacement Roller (Replacement is NYLON not steel)		1	\$16.500
CONCAVE ROLLER				
 G3011	2" Concave Roller <i>For installing spline when installing screen to screen frame. Features concave end.</i>	Nylon	1	\$25.250
G3018	5/32" Replacement Roller		1	\$16.500
COMBINATION ROLLER/KNIFE				
 G3012	Combination Roller and Knife <i>For installing spline when installing screen to frame. Features a concave end and a knife for cutting screen.</i>	Nylon	1	\$50.750
G3018	5/32" Replacement Roller		1	\$15.00
GLASSINE FLAT ROLLER				
 G3015	Glassine Flat Roller <i>For installing both Glassine and spline to screen frame.</i>		1	\$51.000
PLASTIC ROLLER TOOL				
 G3014	Plastic Roller Tool		1	\$4.750
NOTCHING TOOL JIG ASSEMBLY				
 G3020	Notching Tool Jig Assembly <i>For installing Tension Springs, Slide Locks, and Knife Latches in aluminum screen frames.</i>		1	\$167.500
NOTCHING TOOL				
 G3021	Notching Tool <i>For installing Tension Springs, Slide Locks, and Knife Latches in aluminum screen frames.</i>		1	\$53.500
STEP DRILL				
 G3040	7/32" x 1/8" Step Drill <i>2-Step high speed drill bit, to drill proper size hole for Plunger Latches.</i>		1	\$19.500
ALUMINUM WICKET (no screen)				
 G305N	Aluminum Wicket (No Screen) *Mill Finish <i>Opening Width - 9", Opening Height - 6-1/16"</i>	Aluminum	1	\$34.000
VINYL WICKET (no screen)				
 G306	Vinyl Wicket (No Screen) *Gray, Brown, or White <i>Opening Width (Top) - 7-15/16", Opening Width (Btm) - 9-3/16", Opening Height - 5-1/8"</i>	Any*	1	\$12.000



TRU-FRAME®
A name you can build on.

ALUMINUM FRAME SUNSCREENS

SUNSCREEN Pricing Per UNITED INCH

PART NO. DESCRIPTION 0-79 UI 80+ UI

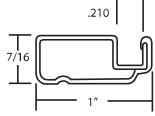

1" ROLL FORM FRAME

HG1130F80	Sunscreen or 80% Suntex	\$1.048	\$0.971
HG1130F90	SuperSolar or 90% Suntex	\$1.162	\$1.072

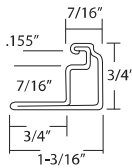

3/4" STANDOFF FRAME

HG1240F80	Sunscreen or 80% Suntex	\$1.199	\$1.132
HG1240F90	SuperSolar or 90% Suntex	\$1.313	\$1.226

ALUMINUM FRAME WINDOW SCREENS

WINDOW SCREEN Pricing Per UNITED INCH

PART NO. DESCRIPTION 0-49 UI 50-79 UI 80+ UI

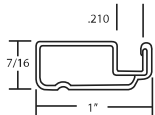

1" ROLL FORM FRAME

HG1130FF	BetterVue® Insect Screen	\$0.905	\$0.792	\$0.689
HG1130FA	Aluminum Wire	\$0.966	\$0.909	\$0.769

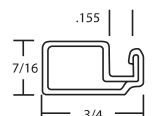

3/4" x 7/16" - ANY COLOR

HG1160FF	BetterVue® Insect Screen	\$0.758	\$0.652	\$0.557
HG1160FA	Aluminum Wire	\$0.856	\$0.778	\$0.630

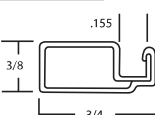

3/4" x 3/8" - ANY COLOR

HG1190FF	BetterVue® Insect Screen	\$0.767	\$0.663	\$0.570
HG1190FA	Aluminum Wire	\$0.865	\$0.790	\$0.644

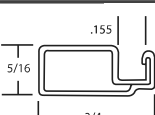

3/4" x 5/16" - ANY COLOR

HG1200FF	BetterVue® Insect Screen	\$0.752	\$0.649	\$0.557
HG1200FA	Aluminum Wire	\$0.849	\$0.774	\$0.630

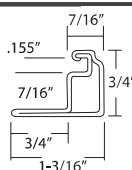

3/4" STANDOFF FRAME

HG1240FF	BetterVue® Insect Screen	\$1.158	\$1.024	\$0.898
HG1240FA	Aluminum Wire	\$1.239	\$1.165	\$0.983

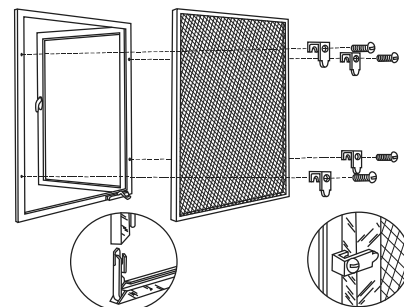
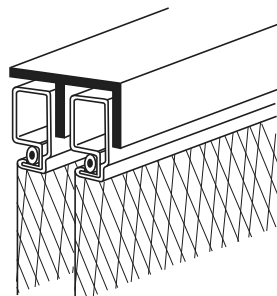
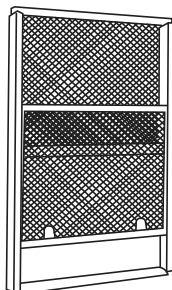

NOTES: United Inch (UI) is calculated by adding width plus height (W+H=UI).
Add \$5.00 to List price per item for applied (punched) hardware. See page 66.

WICKET SCREENS

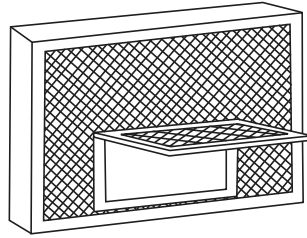
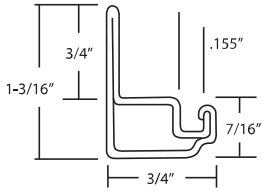

SPECIFICATIONS:

- FRAME:** G1240 - 3/4" Stand-Off
- CORNERS:** Aluminum Stamped, Inside Corners
- FINISH:** White (WH), Gray (GR), Bronze (BR)
- SCREEN:** BetterVue® Insect Screen
- SPLINE:** Black Serrated Vinyl
- HARDWARE:** G1669 - Die cast clip
- WICKET:** Gray, Bronze, or White Vinyl.

ADDITIONS: Aluminum Wire Screening — Add 20% to list
Additional Wickets — Add \$20.00 to list

MEASURING: When ordering, give the exact size desired to the nearest 1/16". No deductions or additions will be made at the factory. For pricing, use the next largest width/height on price list.

WICKET LOCATION: All Wicket locations and operation are viewed from the **Inside Looking Out**.

CONDITIONS: **Screens ordered cannot be canceled or returned for credit.** All purchases are final. Consult factory for packing charges for common carrier shipments.

WIDTH — All measurements in inches

	18	24	30	36
24	\$66.25	\$73.75		
30	\$73.75	\$79.75	\$85.50	
36	\$79.75	\$85.50	\$93.00	\$98.50
42	\$85.50	\$93.00	\$98.50	\$104.00
48	\$93.00	\$98.50	\$104.00	\$111.75
54	\$98.50	\$104.00	\$111.75	\$117.50
60	\$104.00	\$111.75	\$117.50	\$123.00

PASS-THRU SCREENS

SPECIFICATIONS:

- FRAME OPTIONS:** G1160 (3/4" x 7/16")
G1190 (3/4" x 3/8")
G1200 (3/4" x 5/16")
- F-BAR:** G1310 (7/16" F Channel)
- CORNERS:** Aluminum Stamped, Inside Corners
- FINISH:** Mill Finish (MF), White (WH), Gray (GR), and Bronze (BR)
- SCREEN:** BetterVue® Insect Screen
- SPLINE:** Black Serrated Vinyl
- HARDWARE:** G153 - Pull Tabs, G150 - Flat Window Springs.

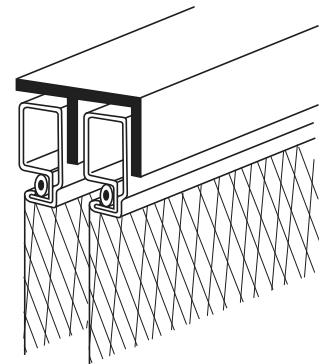
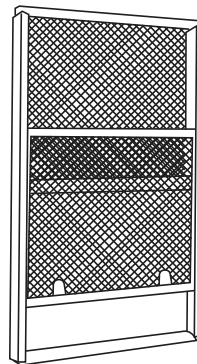

WIDTH — All measurements in inches

	24	30	36	48
60	\$155.75	\$181.75	\$192.00	\$209.25

ADDITIONS: Aluminum Wire Screening — Add 20% to list

MEASURING: When ordering, give the exact size desired to the nearest 1/16". No deductions or additions will be made at the factory. For pricing, use the next largest width/height on price list.

CONDITIONS: **Screens ordered cannot be canceled or returned for credit.** All purchases are final. Consult factory for packing charges for common carrier shipments.



TRU-FRAME®
A name you can build on.

CUSTOM SHAPE WINDOW SCREENS

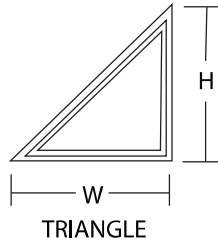

TRIANGLE

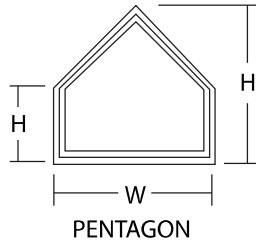

PENTAGON

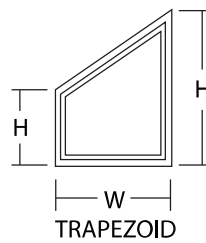

TRAPEZOID

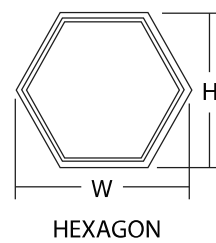

HEXAGON
(All Sides Equal)

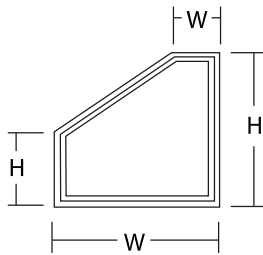

PENTAGON
W/ FLAT TOP

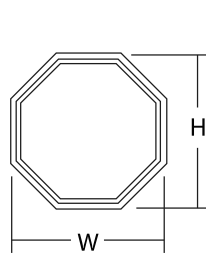

OCTAGON
(All Sides Equal)

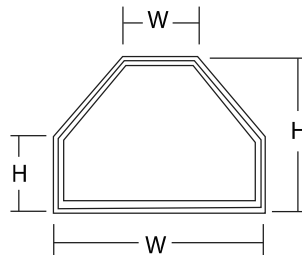

HEXAGON
W/ FLAT TOP

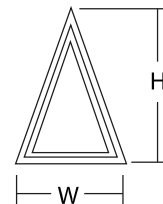

ISOSCELES
TRIANGLE

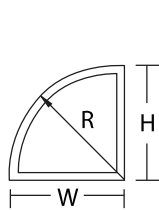

QUARTER
CIRCLE LEFT

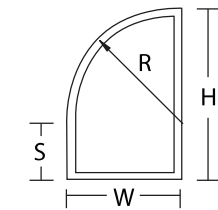

QUARTER CIRCLE LEFT
W/ EXTENDED LEGS

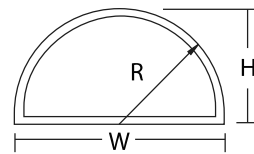

HALF CIRCLE

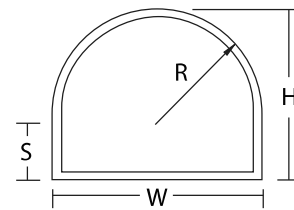

HALF CIRCLE
W/ EXTENDED LEGS

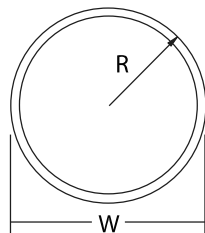

FULL CIRCLE

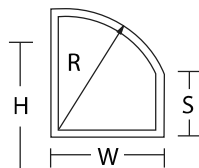

QUARTER ARCHTOP
W/ EXTENDED LEGS

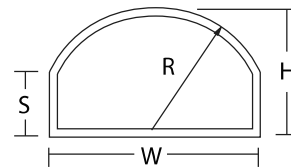

ARCHTOP
W/ EXTENDED LEGS

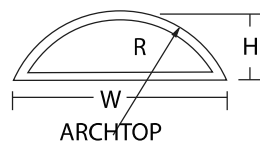

ARCHTOP

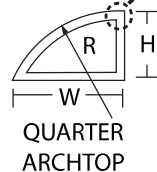

QUARTER
ARCHTOP

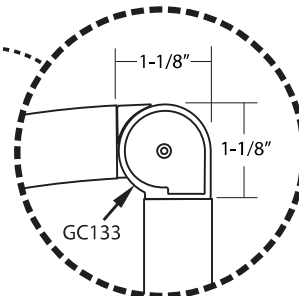





NOTE: 22" Minimum width on arch top window screen frames.
NOTE: All non-90° angles are connected using an adjustable plastic corner. (See detail above).

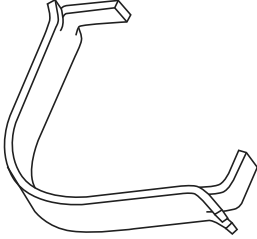

TRU-FRAME®
A name you can build on.

WINDOW SCREEN HARDWARE

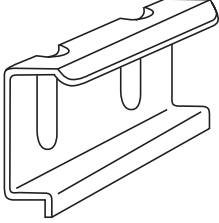
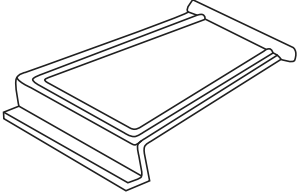
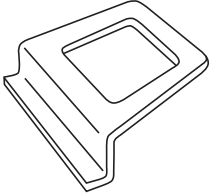
SECTION H

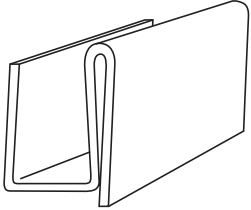
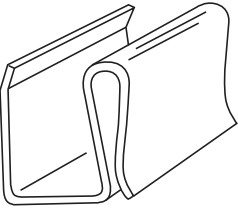
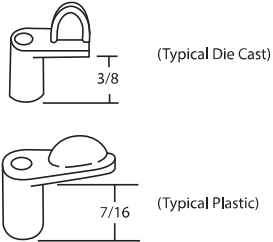
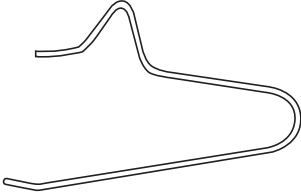
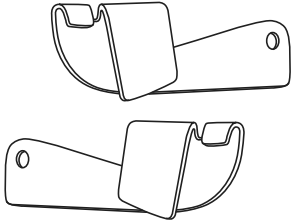
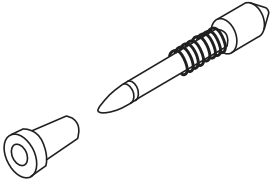
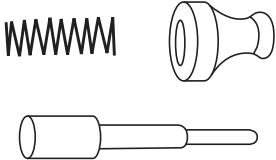
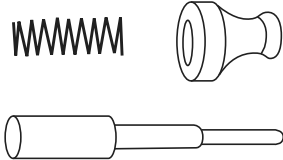
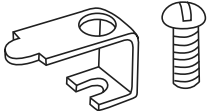
<p>G147 Double Jiffy</p> 	<p>G150 Flat Window Spring Clips</p> 	<p>G151WD Corner Leaf Spring</p> 	<p>G152 3/4" Lift Clips</p> 
<p>G153 Nylon Pull Tabs</p> 	<p>G154 Nylon Pull Loops</p> 	<p>G161 Slide Locks</p> 	<p>G164 — 3/8" Metal Retainer Clip G165 — 7/16" Metal Retainer Clip</p> 
<p>G169 Plastic Retainer Clip</p> 	<p>G1661 — G1669 - Die Cast Clips</p> 	<p>G175 Wire Window Clip</p> 	<p>G176 Security Latch Pair</p> 
<p>G177 Nylon Plunger Latch</p> 	<p>G178 3/4" Aluminum Plunger Latch</p> 	<p>G179 1" Aluminum Plunger Latch</p> 	<p>G180 - G183 Casement Clips</p> 



TRU-FRAME®
A name you can build on.

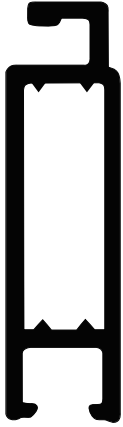

D2010
1-7/8" x 1/2"



G2130
1" x 3/8"

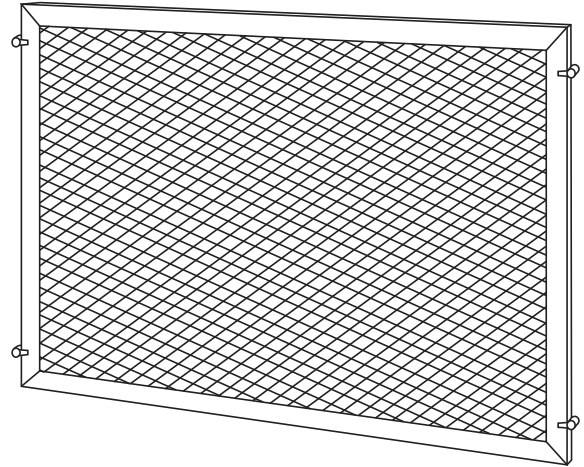

1. **GENERAL:**

Architectural screens shall be quality screens as manufactured by R. Lang Company, Visalia, California, and shall include all fitting pieces and hardware for a complete installation as hereinafter described.

2. **MATERIALS:**

- A. *SCREEN FRAMES* shall be extruded from aluminum alloy 6063-T5, and shall have a minimum wall thickness of .050. Screen frames shall be of the following dimensions: 1-7/8" x 1/2" — 1" x 7/16" (Other frames are available).
- B. *SPLINE* for the retention of wire cloth shall be vinyl plastic matching the contour of the spline groove in the screen frame for maximum holding power. Spline shall be removable to permit replacement of wire cloth.
- C. *CORNERS* shall be solid in construction and shall be manufactured from the same material as the frame.
- D. *WIRE CLOTH* shall be BetterVue® Insect Screen. (Other types of wire cloth and shade screening are available; contact the factory for recommendations.)

3. **CONSTRUCTION:**

Corners of screen frames shall be mitred and assembled with solid aluminum corners.

4. **FINISH:**

Extruded screen frames shall be finished to the following specifications:

- A. Commercial clear (Satin) anodize
- B. Commercial bronze anodize

5. **PRICING:**

Call factory for quote – Have our inside sales representatives help you design your project!



TRU-FRAME®
A name you can build on.

Window Screens

Fax Number: 888-526-4329

ORDER QUOTE (Check One)

DATE: _____

DEALER: _____

JOB NAME/PO#: _____

CUSTOMER'S
SIGNATURE: _____

INSTRUCTIONS:

Write the part number(s) and location of hardware in the above illustration. Check the desired corner. Write the quantity, size, frame, finish, and screening in the spaces provided. Use one page for each screen configuration.

Hardware: See page G
Frames: See Section G
Screening: See Section F

Specify Corners (Check One):

- Inside Aluminum (mitred)
- Outside Plastic (square cut)

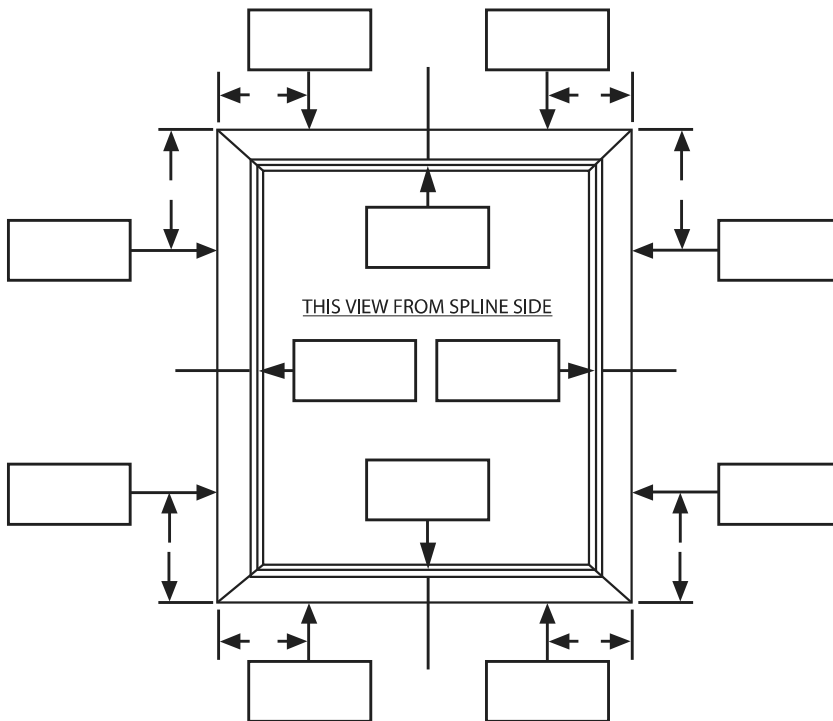

QTY	SIZE	FRAME	FINISH	CORNER	SCREEN	HDW

SECTION H

SECTION K



TRU-FRAME®
A name you can build on.



Visit us at www.greenhousewindows.com
for more information

Patent #: D320-682
Patent #: 6,588,146 B1



TRU-FRAME®
A name you can build on.

VINYL GREENHOUSE WINDOWS

PART NO.	NOMINAL SIZE	ROUGH OPENING	FINISHED OPENING	INSIDE DIMENSION	FIN-to-FIN DIMENSION	WHITE (WH)	Almond (AM) TAN (TN)
KI3030	3'0" x 3'0"	36" x 36"	35" x 35"	34 1/2" x 34 3/4"	43" x 40 1/8"	\$1,443.50	\$1,574.00
KI3036	3'0" x 3'6"	36" x 42"	35" x 41"	34 1/2" x 40 3/4"	43" x 46 1/8"	\$1,492.50	\$1,627.50
KI3039	3'0" x 3'9"	36" x 45"	35" x 44"	34 1/2" x 43 3/4"	43" x 49 1/8"	\$1,517.50	\$1,655.00
KI3040	3'0" x 4'0"	36" x 48"	35" x 47"	34 1/2" x 46 3/4"	43" x 52 1/8"	\$1,544.00	\$1,686.00
KI3050	3'0" x 5'0"	36" x 60"	35" x 59"	34 1/2" x 58 3/4"	43" x 64 1/8"	\$1,640.00	\$1,788.50
KI4030	4'0" x 3'0"	48" x 36"	47" x 35"	46 1/2" x 34 3/4"	55" x 40 1/8"	\$1,580.00	\$1,722.00
KI4036	4'0" x 3'6"	48" x 42"	47" x 41"	46 1/2" x 40 3/4"	55" x 46 1/8"	\$1,630.50	\$1,779.00
KI4039	4'0" x 3'9"	48" x 45"	47" x 44"	46 1/2" x 43 3/4"	55" x 49 1/8"	\$1,707.50	\$1,861.00
KI4040	4'0" x 4'0"	48" x 48"	47" x 47"	46 1/2" x 46 3/4"	55" x 52 1/8"	\$1,735.00	\$1,893.00
KI4050	4'0" x 5'0"	48" x 60"	47" x 59"	46 1/2" x 58 3/4"	55" x 64 1/8"	\$1,842.50	\$2,007.50
KI5030	5'0" x 3'0"	60" x 36"	59" x 35"	58 1/2" x 34 3/4"	67" x 40 1/8"	\$1,839.00	\$2,004.50
KI5036	5'0" x 3'6"	60" x 42"	59" x 41"	58 1/2" x 40 3/4"	67" x 46 1/8"	\$1,899.50	\$2,071.50
KI5039	5'0" x 3'9"	60" x 45"	59" x 44"	58 1/2" x 43 3/4"	67" x 49 1/8"	\$1,991.50	\$2,173.00
KI5040	5'0" x 4'0"	60" x 48"	59" x 47"	58 1/2" x 46 3/4"	67" x 52 1/8"	\$2,022.00	\$2,205.00
KI5050	5'0" x 5'0"	60" x 60"	59" x 59"	58 1/2" x 58 3/4"	67" x 64 1/8"	\$2,144.50	\$2,338.50
KI6030	6'0" x 3'0"	72" x 36"	71" x 35"	70 1/2" x 34 3/4"	79" x 40 1/8"	\$1,922.50	\$2,097.00
KI6036	6'0" x 3'6"	72" x 42"	71" x 41"	70 1/2" x 40 3/4"	79" x 46 1/8"	\$2,005.50	\$2,186.50
KI6039	6'0" x 3'9"	72" x 45"	71" x 44"	70 1/2" x 43 3/4"	79" x 49 1/8"	\$2,105.50	\$2,297.50
KI6040	6'0" x 4'0"	72" x 48"	71" x 47"	70 1/2" x 46 3/4"	79" x 52 1/8"	\$2,140.50	\$2,335.00
KI6050	6'0" x 5'0"	72" x 60"	71" x 59"	70 1/2" x 58 3/4"	79" x 64 1/8"	\$2,277.50	\$2,486.00

Exterior Colors/Options:

White and Almond are in stock. Special exterior colors are available on request
Add color option required to part number above. (Example: KI3030WH)

WH = White AM = Almond TN = Tan SP = Special

Interior Colors/Options:

White Interior is standard on Special color exteriors

Black Bottom Pan is standard on Almond and Tan windows

Special Sizes Available:

Window is available in Rough Opening sizes between 2'0" x 2'6" and 6'0" x 5'0"

Special Order Form available (download at www.truframe.com/catalog)

NOTE: Customs unit cannot be cancelled or returned.

Glazing System/Options:

Low-E2 insulated top, and clear front & sides 3/4" IGUs are standard
Call factory for special glass and pricing. Single Glazing is not available

Adjustable Shelf System:

A Tempered Glass Shelf is standard. An Amplimesh Shelf is also available and can be substituted for a nominal fee.

Support Required:

Support Bracing is **STRONGLY** recommended on each end of the window. Support brackets are not included on windows under 5'0" width, but can be purchased separately. Brackets are located on page 71 for Aluminum Windows and page 79 for Vinyl Windows. Support Bracing is **REQUIRED** on each end of a window 5'0" width or greater & brackets are included (2 each) when window ordered meets or exceeds this width.

Building Codes vary greatly between States and Counties, and R. Lang Company **cannot be held liable** for knowing a customer's specific regulations or product application. It is up to the builder/contractor/architect to verify products are within compliance before order is placed.



NOTE: Vent operation will be limited for windows with a (RO) Rough Opening under 30"

Patent #: D320-682
Patent #: 6,588,146 B1



TRU-FRAME®
A name you can build on.

VINYL RETRO-FIT GREENHOUSE WINDOWS

PART NO.	OPENING SIZES	WHITE (WH)	ALMOND (AM) / TAN (TN)
KR3030	Up to 36" x 36"	\$1,738.00	\$1,978.50
KR3040	Up to 36" x 48"	\$1,859.50	\$2,119.00
KR3050	Up to 36" x 60"	\$1,975.50	\$2,248.00
KR4030	Up to 48" x 36"	\$1,901.50	\$2,165.50
KR4040	Up to 48" x 48"	\$2,088.50	\$2,378.00
KR4050	Up to 48" x 60"	\$2,219.50	\$2,523.50
KR5030	Up to 60" x 36"	\$2,215.00	\$2,519.50
KR5040	Up to 60" x 48"	\$2,433.00	\$2,770.50
KR5050	Up to 60" x 60"	\$2,581.00	\$2,938.00
KR6030	Up to 72" x 36"	\$2,314.50	\$2,634.50
KR6040	Up to 72" x 48"	\$2,577.00	\$2,935.00
KR6050	Up to 72" x 60"	\$2,860.50	\$3,258.00

Exterior Colors/Options:

White and Almond are in stock. Special exterior colors are available on request. Add color option required to part number above. (Example: KR3030WH)

WH = White TN = Tan AM = Almond SP = Special

Interior Colors/Options:

White Interior is standard on Special color exteriors

Black Bottom Pan is standard on Almond and Tan windows

Special Sizes Available:

Window is available in Rough Opening sizes between 2'0" x 2'6" and 6'0" x 5'0"
Special Order Form available (download at www.truframe.com/catalog)

Custom units cannot be cancelled or returned

Glazing System/Options:

Low-E2 insulated top, and clear front & side 3/4" IGUs are standard

Call factory for special glass and pricing. Single Glazing is not available.

Adjustable Shelf System:

A Tempered Glass Shelf is standard. An Amplimesh Shelf is also available and can be substituted for a nominal fee.

Support Required:

Support Bracing is STRONGLY recommended on each end of the window. Support brackets are not included on windows under 5'0" width, but can be purchased separately. Brackets are located on page 71 for Aluminum Windows and page 79 for Vinyl Windows.

Support Bracing is REQUIRED on each end of a window 5'0" width or greater & brackets are included (2 each) when window ordered meets or exceeds this width.

Building Codes vary greatly between States and Counties, and R. Lang Company cannot be held liable for knowing a customer's specific regulations or product application. It is up to the builder/contractor/architect to verify products are within compliance before order is placed.

NOTE: Vent operation will be limited for windows with a (RO) Rough Opening under 30".

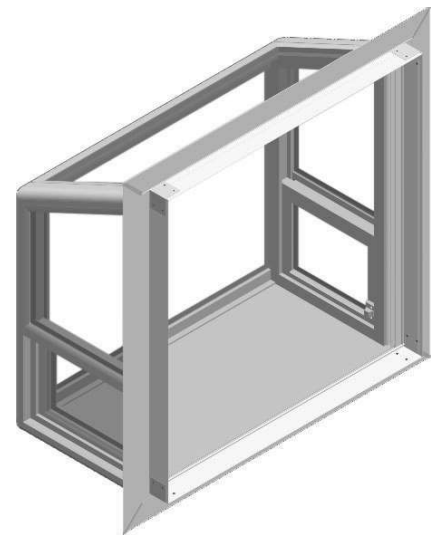

Patent #: D320-682
Patent #: 6,588,146 B1



TRU-FRAME®
A name you can build on.

VINYL GREENHOUSE WINDOW ACCESSORIES

PART NO. DESCRIPTION STANDARD WINDOW WIDTH LIST PRICE

TEMPERED GLASS SHELF KITS

KA3000KS	Tempered Glass Shelf Kit	3'0" Width	\$152.00
KA4000KS	Tempered Glass Shelf Kit	4'0" Width	\$188.00
KA5000KS	Tempered Glass Shelf Kit	5'0" Width	\$232.00
KA6000KS	Tempered Glass Shelf Kit	6'0" Width	\$286.50

Specify Color: White (WH), Almond (AM), Special (SP) Tan (TN) Example: KA3000KSWH
Kits Include: Tempered glass shelf, 2-extruded aluminum shelf supporters, 4-shelf clips.

ALUMINUM AMPLIMESH SHELF KITS

KA3010KS	Aluminum Amplimesh Shelf Kit	3'0" Width	\$136.50
KA4010KS	Aluminum Amplimesh Shelf Kit	4'0" Width	\$168.50
KA5010KS	Aluminum Amplimesh Shelf Kit	5'0" Width	\$209.50
KA6010KS	Aluminum Amplimesh Shelf Kit	6'0" Width	\$258.00

Specify Color: White (WH), Almond (AM), Special (SP) Tan (TN) Example: KA3010KSWH
Kits Include: Amplimesh shelf, 2-extruded aluminum shelf supporters, 4-shelf clips.

TOUCH-UP SPRAY PAINT

KM1150AM	Almond touch-up spray paint	12oz can	\$61.00
KM1150WH	White touch-up spray paint	12oz can	\$61.00
KM1150TN	Tan touch-up spray paint	12oz can	\$61.00

STUCCO MOLDING

J3118AM	Stucco Molding - Almond	15' Lengths	\$88.50
J3118WH	Stucco Molding - White	15' Lengths	\$88.50

REPLACEMENT SHELF CLIPS

JA9001NSBR	Snap in Shelf Clip - Bronze		\$2.50
JA9001NSWH	Snap in Shelf Clip - White		\$2.50
JA9001NSAM	Snap in Shelf Clip - Almond		\$2.50
JA9001NSTN	Snap in Shelf Clip - Tan		\$2.50

SHELF STANDARDS

KA9004NSAM	Shelf Standard - Almond Aluminum	24"	\$14.00
KA9004NSTN	Shelf Standard - Tan Aluminum	24"	\$14.00
KA9004NSBR	Shelf Standard - Bronze Aluminum	24"	\$14.00
KA9004NSWH	Shelf Standard - White Aluminum	24"	\$14.00

SUPPORT BRACKETS (Note: Factory recommends (2) brackets for windows 5'0" and larger – included with kits)

J1010WH	Support Bracket - White	1 each	\$60.50
J1010TN	Support Bracket - Tan	1 each	\$60.50
J1010AM	Support Bracket - Almond	1 each	\$60.50

WINDOW DISPLAY

KDS1000	Showroom Floor Display		\$1,600.00
---------	------------------------	--	------------

Includes: 1 K13030WH, 1 floor display with sign (assembly required), & 100 consumer handouts.

Patent #: D320-682
Patent #: 6,588,146 B1



TRU-FRAME®
A name you can build on.

STUCCO MOLDING FOR GREENHOUSE WINDOWS

Part Number: J3118
Length: 15-ft each
Finishes: Bronze Paint
White
Desert Sand

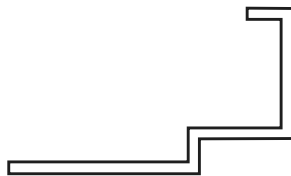

Actual Size

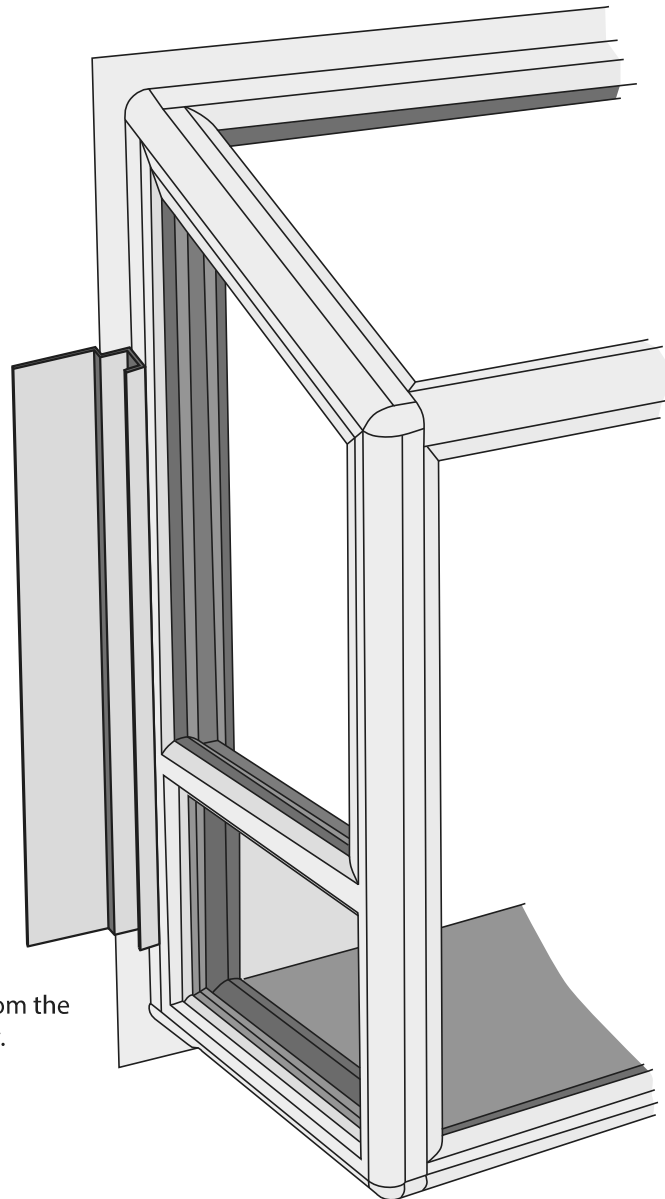

Pocket faces away from the
Greenhouse Window.

Patent #: D320-682
Patent #: 6,588,146 B1

New Construction Detail

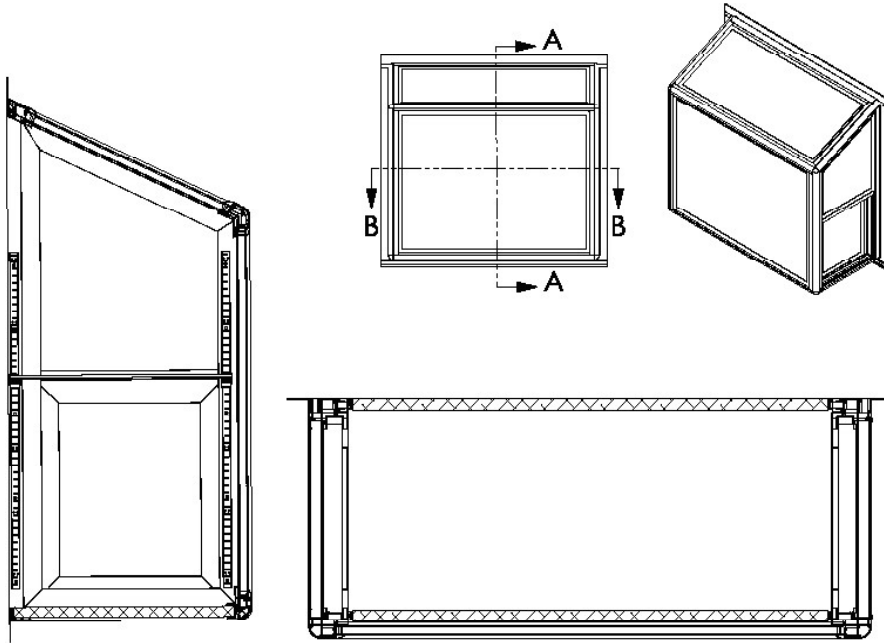

SECTION A-A
SCALE 1 : 6

SECTION B-B
SCALE 1 : 6

GARDEN WINDOW ILLUSTRATIONS
SHEET 1 OF 1

***Retro-Fit and Inside
Finish Detail***

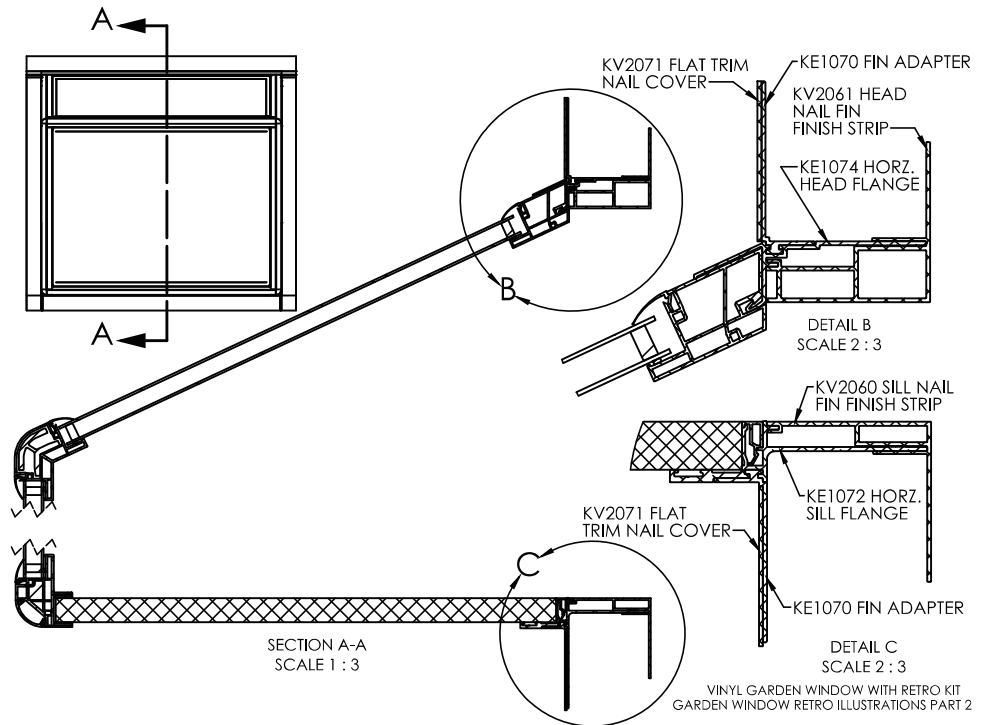

SECTION A-A
SCALE 1 : 3

DETAIL B
SCALE 2 : 3

DETAIL C
SCALE 2 : 3

VINYL GARDEN WINDOW WITH RETRO KIT
GARDEN WINDOW RETRO ILLUSTRATIONS PART 2



TRU-FRAME® A name you can build on.

ORDER [] QUOTE [] (Check One)

"KI" Series (nail on fin) Vinyl Greenhouse Window Fax Number: 888-526-4329

DATE: _____

DEALER: _____

JOB NAME/PO#: _____

1. QUANTITY (Same Specifications): _____

- 2. GLAZING (Insulated Only): [] Standard (Low-E2 top, clear front & sides) [] Special Glass (Please Specify Type):

TOP VIEW

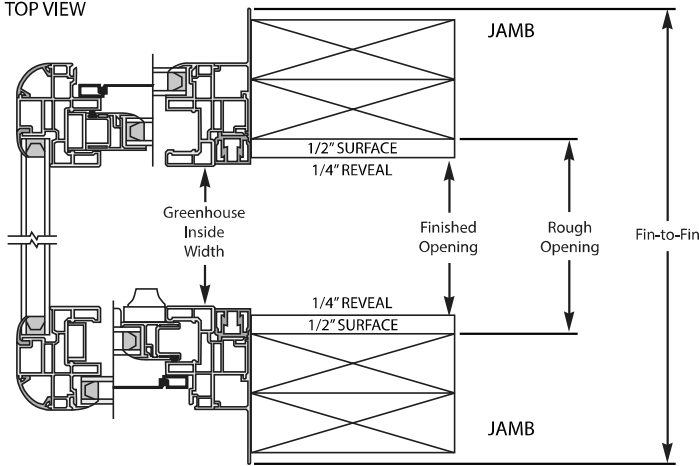

Top Front Sides

[] Tempered Glass (All Panels Only)

Call Customer Service for pricing on Special Glass Options.

3. FRAME DIMENSIONS:

[] Standard Frame Sizes (For Special Glazing)

Width _____ x Height _____

[] Special Frame Sizes (Refer To Diagram At Left)

Please provide where dimensions are taken from:

- [] Greenhouse Inside Dimension (GID) [] Finished Opening (FO) [] Rough Opening (RO)

Width _____ x Height _____

\$60.00 NET add to next larger size for Special Frame Sizes.

4. FRAME COLOR:

- [] White [] Almond [] Tan [] Other (Specify): _____

Call Customer Service for pricing on special color options.

5. TEMPERED GLASS SHELF:

- [] Tempered Glass Shelf (Standard) [] Aluminum Applimesh Shelf [] Additional shelves (Quantity): _____

I agree to pay in full, within terms, for SPECIAL(s) built to the specifications above. (SPECIALS ARE NON-RETURNABLE).

SIDE VIEW

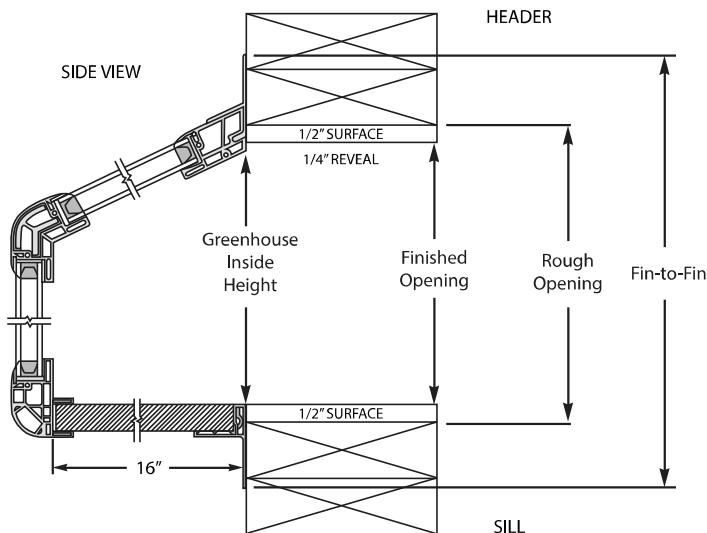

Authorized Signature

Order Date

Patent #: D320-682 Patent #: 6,588,146 B1



TRU-FRAME®
A name you can build on.

"KR" Series (Retrofit) Vinyl Greenhouse Window
Fax Number: 888-526-4329

DATE: _____

DEALER: _____

JOB NAME/PO#: _____

ORDER QUOTE (Check One)

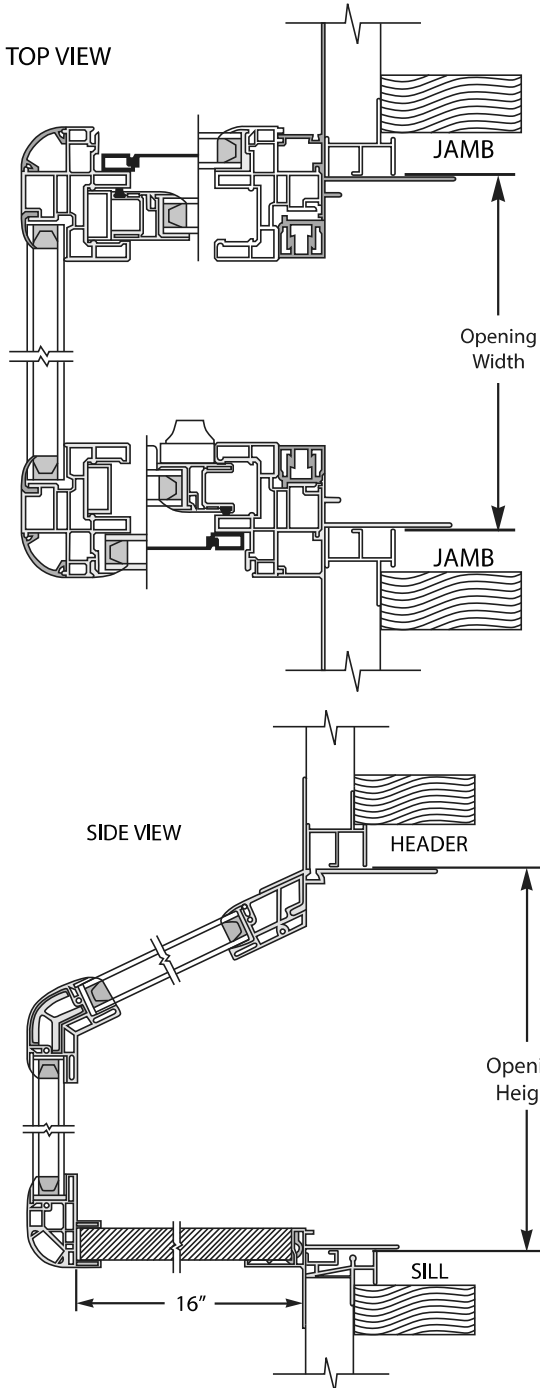

1. **QUANTITY** (Same Specifications): _____

2. **GLAZING** (Insulated Only):

- Standard (Low-E2 top, clear front & sides)
- Special Glass (Please Specify Type):

_____ Top _____ Front _____ Sides

Tempered Glass (All Panels Only)

Call Customer Service for pricing on Special Glass Options.

3. **FRAME DIMENSIONS:**

Frame Size (Refer To Diagram At Left)
Please provide NET opening size.

Width _____ x Height _____

4. **FRAME COLOR:**

- White
- Almond
- Tan
- Other (Specify): _____

Call Customer Service for pricing on special color options.

5. **TEMPERED GLASS SHELF:**

- Tempered Glass Shelf (Standard)
- Aluminum Amplimesh Shelf
- Additional shelves (Quantity): _____

I agree to pay in full, within terms, for SPECIAL(s) built to the specifications above. (SPECIALS ARE NON-RETURNABLE).

Authorized Signature

Order Date



TRU-FRAME®
A name you can build on.

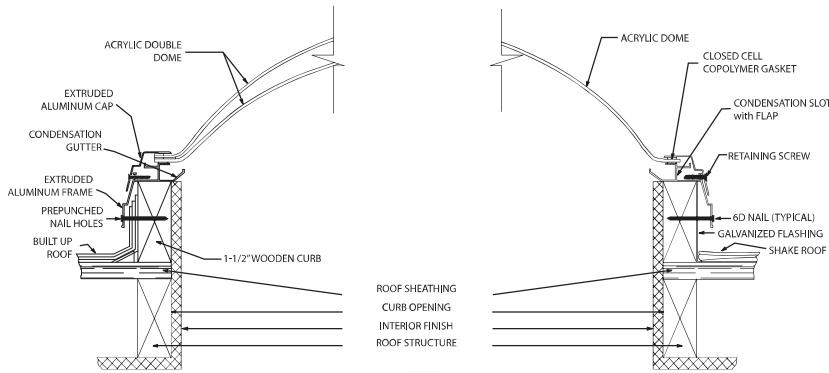

ACRYLIC DOME FIXED CURB MOUNT SKYLIGHT

FRAME FINISH

- = Mill Finish
- = Bronze Paint

(Special Orders Only)

* All other Tru-Frame® custom colors are available – Call for quote

DOMES OPTIONS

- | | |
|---------------|--------------------|
| <u>Single</u> | <u>Double Dome</u> |
| C = Clear | CC = Clear/Clear |
| B = Bronze | BC = Bronze/Clear |
| W = White | WC = White/Clear |

MODEL NO.	WOOD CURB OUTSIDE DIMENSION*	MILL FINISH SINGLE DOME	MILL FINISH DOUBLE DOME	BRONZE FINISH SINGLE DOME	BRONZE FINISH DOUBLE DOME
LC1616	17-1/2" x 17-1/2"	\$203.00	\$239.50	\$212.00	\$252.00
LC1624	17-1/2" x 25-1/2"	\$230.00	\$279.50	\$245.00	\$294.00
LC1632	17-1/2" x 33-1/2"	\$258.00	\$321.50	\$273.00	\$335.50
LC1648	17-1/2" x 49-1/2"	\$329.50	\$417.50	\$345.50	\$435.50
LC2424	25-1/2" x 25-1/2"	\$261.00	* \$327.00	\$276.00	* \$341.00
LC2432	25-1/2" x 33-1/2"	\$311.00	\$392.00	\$325.00	\$407.00
LC2436	25-1/2" x 37-1/2"	\$324.50	\$419.00	\$340.50	\$435.00
LC2448	25-1/2" x 49-1/2"	\$375.00	* \$494.50	\$392.00	* \$509.00
LC2472	25-1/2" x 73-1/2"	\$536.00	\$719.00	\$555.00	\$734.00
LC2496	25-1/2" x 97-1/2"	\$644.50	\$874.50	\$666.50	\$897.00
LC3232	33-1/2" x 33-1/2"	\$354.00	\$463.00	\$365.00	\$476.00
LC3248	33-1/2" x 49-1/2"	\$488.00	\$647.50	\$503.00	\$665.00
LC3272	33-1/2" x 73-1/2"	\$620.50	\$850.00	\$635.00	\$861.50
LC3296	33-1/2" x 97-1/2"	\$966.00	\$1,454.50	\$976.50	\$1,451.50
LC3636	37-1/2" x 37-1/2"	\$414.50	\$538.00	\$449.50	\$558.00
LC3648	37-1/2" x 49-1/2"	\$483.50	\$641.00	\$518.00	\$659.50
LC3672	37-1/2" x 73-1/2"	\$791.50	\$1,163.50	\$839.00	\$1,179.50
LC4848	49-1/2" x 49-1/2"	\$536.50	\$728.50	\$558.00	\$769.50
LC4872	49-1/2" x 73-1/2"	\$921.50	\$1,388.00	\$938.00	\$1,437.00
LC4896	49-1/2" x 97-1/2"	\$1,132.00	\$1,749.00	\$1,153.00	\$1,806.50

(* Denotes **STOCK SIZE** Skylights. All other sizes listed above are **NON-STOCK STANDARD** sizes.

SPECIAL SIZES are available, see Special Order Instruction Sheet for this section. Outside curb dimension does NOT include flashing..

See "Shipping Terms & Conditions" page for **RE-STOCK FEES** on returns. **SPECIAL SKYLIGHTS CANNOT BE CANCELLED OR RETURNED.**

Building Codes vary greatly between States and Counties, and R. Lang Company cannot be held liable for knowing a customer's specific regulations or product application. It is up to the builder/contractor/architect to verify products are within compliance before order is placed.

PACKAGING: All skylights are polywrapped.

See [Packaging Chart](#) located in "Shipping Terms and Conditions" to calculate Packaging Fees for orders shipping Common Carrier.

NOTE: Recommend a minimum 3/12 roof pitch for proper weeping. Flat roof installation NOT recommended and voids warranty.



TRU-FRAME®
A name you can build on.

**OPEN-AIR ACRYLIC DOME
CURB MOUNT SKYLIGHT**

FRAME FINISH

- ▨ = Mill Finish
- = Bronze Paint

(Special Orders Only)

* All other Tru-Frame® custom colors are available – Call for quote

DOME OPTIONS

Single

- C = Clear
- B = Bronze
- W = White

Double Dome

- CC = Clear/Clear
- BC = Bronze/Clear
- WC = White/Clear

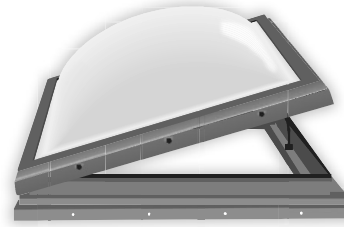
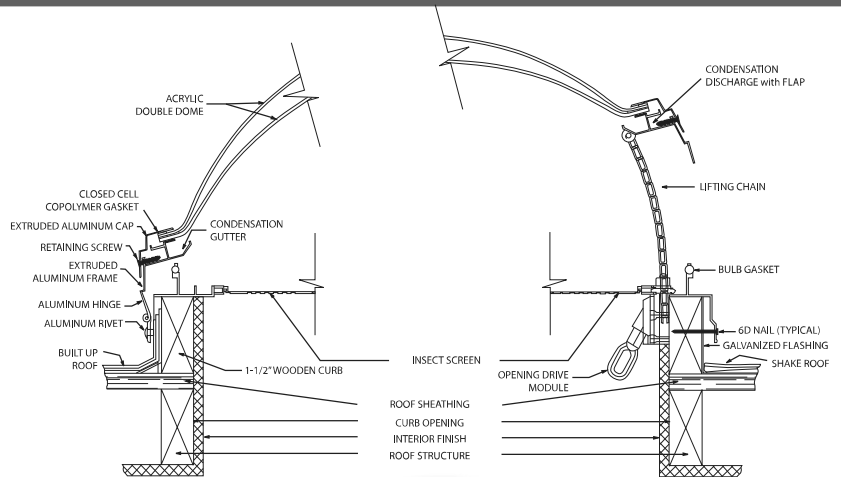

MODEL NO.	WOOD CURB OUTSIDE DIMENSION*	MILL FINISH SINGLE DOME	MILL FINISH DOUBLE DOME	BRONZE FINISH SINGLE DOME	BRONZE FINISH DOUBLE DOME
LO2424	25-1/2" x 25-1/2"	\$644.50	\$703.00	\$673.00	* \$774.00
LO2432	25-1/2" x 33-1/2"	\$693.00	\$786.50	\$605.50	\$846.50
LO2436	25-1/2" x 37-1/2"	\$714.00	\$839.50	\$750.00	\$878.50
LO2448	25-1/2" x 49-1/2"	\$759.50	* \$909.50	\$797.00	* \$951.00
LO2472	25-1/2" x 73-1/2"	\$1,088.00	\$1,192.00	\$947.50	\$1,360.00
LO2496	25-1/2" x 97-1/2"	\$916.00	\$992.00	\$986.00	\$1,168.50
LO3232	33-1/2" x 33-1/2"	\$725.50	\$866.50	\$674.00	\$902.50
LO3248	33-1/2" x 49-1/2"	\$739.00	\$1,073.50	\$981.00	\$1,116.00
LO3272	33-1/2" x 73-1/2"	\$983.50	\$1,446.50	\$1,083.50	\$1,503.00
LO3296	33-1/2" x 97-1/2"	\$1,604.00	\$1,545.50	\$1,383.00	\$1,690.00
LO3636	37-1/2" x 37-1/2"	\$834.00	\$989.50	\$769.00	\$1,029.50
LO3648	37-1/2" x 49-1/2"	\$880.50	\$1,193.50	\$932.50	\$1,306.00
LO4848	49-1/2" x 49-1/2"	\$1,062.00	\$1,223.00	\$1,107.00	\$1,338.50
LO4872	49-1/2" x 73-1/2"	\$1,507.50	\$1,751.00	\$1,393.50	\$1,902.00
LO4896	49-1/2" x 97-1/2"	\$1,737.50	\$2,052.00	\$1,605.00	\$2,231.00

(*) Denotes **STOCK SIZE** Skylights. All other sizes listed above are **NON-STOCK STANDARD** sizes.

SPECIALS SIZES are available, see Special Order Instruction Sheet for this section. Outside curb dimension does NOT include flashing.

See "Shipping Terms & Conditions" page for **RE-STOCK FEES** on returns. **SPECIAL SKYLIGHTS CANNOT BE CANCELLED OR RETURNED.**

Building Codes vary greatly between States and Counties, and R. Lang Company cannot be held liable for knowing a customer's specific regulations or product application. It is up to the builder/contractor/architect to verify products are within compliance before order is placed.

OPEN-AIR SKYLIGHTS are equipped with an aluminum wire screen and operator pole which will extend from 6 to 10 feet.

STANDARD HINGE LOCATION for rectangular Open-Air Skylights is on the short side. If a unit is to be hinged on the long side, this must be specified when ordering. Add \$60.00 list to prices above for specified hinge location.

ELECTRICAL OPERATOR - An electrically operated, 24-volt DC motor can be used with, or substituted for, the manual operator. Call Customer Service for more information regarding Electric Operators.

PACKAGING - All LO models are boxed.

See Packaging Chart located in "Shipping Terms and Conditions" to calculate Packaging Fees for orders shipping Common Carrier.

NOTE: Recommend a minimum 3/12 roof pitch for proper weeping. Flat roof installation NOT recommended and voids warranty.



TRU-FRAME®
A name you can build on.

FLAT GLASS CURB MOUNT SKYLIGHT

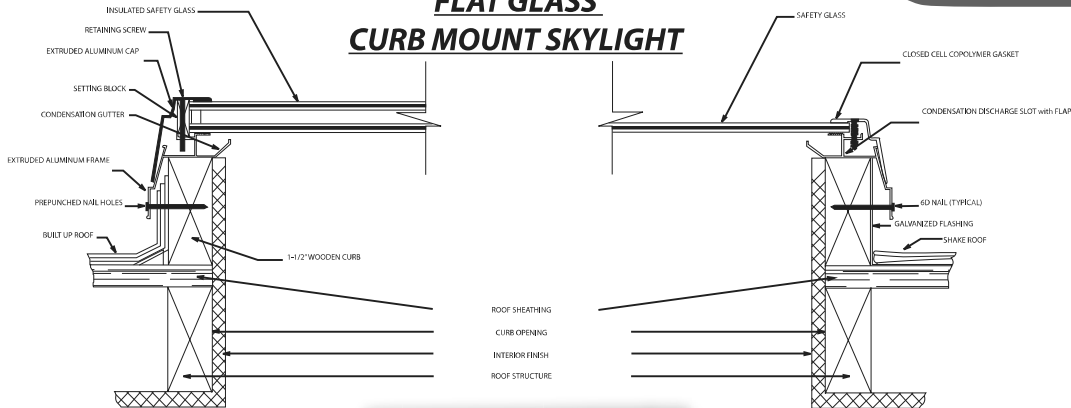

FRAME FINISH

- = Mill Finish
- = Bronze Paint

(Special Orders Only)

* All other Tru-Frame® custom colors are available – Call for quote

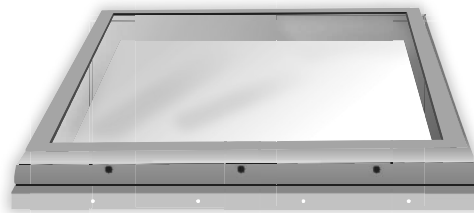

MILL FINISH
LIST PRICE

GLASS OPTIONS

Single

L = Laminated (Clear)

Insulated (Tempered/Laminated)

CL = Clear

BL = Bronze

EL = Low-E2

SL = Solar Cool Bronze

PART NO.	WOOD CURB OUTSIDE DIMENSION*	SINGLE (L)	INSULATED (CL)	INSULATED (BL)	INSULATED (EL)	INSULATED (SL)
LCG2424	25-1/2" x 25-1/2"	\$322.00	\$414.50	\$427.50	\$466.00	\$576.50
LCG2436	25-1/2" x 37-1/2"	\$418.00	\$559.00	\$574.50	\$633.50	\$812.50
LCG2448	25-1/2" x 49-1/2"	\$500.50	\$694.00	\$715.50	\$795.50	\$1,040.00
LCG2472	25-1/2" x 73-1/2"	\$713.50	\$999.00	\$1,033.00	\$1,155.00	\$1,429.00
LCG2496	25-1/2" x 97-1/2"	\$883.00	\$1,264.50	\$1,361.50	\$1,475.00	\$1,856.50
LCG3636	37-1/2" x 37-1/2"	\$565.50	\$776.00	\$799.00	\$904.00	\$1,100.00
LCG3648	37-1/2" x 49-1/2"	\$680.50	\$962.50	\$996.50	\$1,137.00	\$1,446.00
LCG4848	49-1/2" x 49-1/2"	\$813.00	\$1,216.50	\$1,252.50	\$1,480.50	\$1,831.00

BRONZE FINISH
LIST PRICE

PART NO.	WOOD CURB OUTSIDE DIMENSION*	SINGLE (L)	INSULATED (CL)	INSULATED (BL)	INSULATED (EL)	INSULATED (SL)
LCG2424	25-1/2" x 25-1/2"	\$339.50	* \$441.00	* \$442.50	* \$490.00	\$596.00
LCG2436	25-1/2" x 37-1/2"	\$437.50	\$585.00	\$592.50	\$665.00	\$832.50
LCG2448	25-1/2" x 49-1/2"	\$524.00	* \$725.00	* \$732.00	* \$827.50	\$1,063.50
LCG2472	25-1/2" x 73-1/2"	\$719.50	\$1,008.00	\$1,037.00	\$1,172.00	\$1,446.00
LCG2496	25-1/2" x 97-1/2"	\$920.50	\$1,312.50	\$1,357.00	\$1,523.00	\$1,891.00
LCG3636	37-1/2" x 37-1/2"	\$594.50	\$803.50	\$859.00	\$935.00	\$1,127.00
LCG3648	37-1/2" x 49-1/2"	\$719.50	\$996.50	\$1,030.50	\$1,172.00	\$1,480.50
LCG4848	49-1/2" x 49-1/2"	\$849.50	\$1,259.50	\$1,271.00	\$1,517.50	\$1,860.00

(*) Denotes **STOCK SIZE** Skylights. All other sizes listed above are **NON-STOCK STANDARD** sizes. **SPECIALS** are available, see Special Order Instruction Sheet for this section. See "Shipping Terms and Conditions" page for **RE-STOCK FEES** on returns. **SPECIAL SKYLIGHTS CANNOT BE CANCELLED OR RETURNED.** Outside curb dimension **DOES NOT** include flashing.

Glass skylights can NOT be manufactured with more than 16 sq. ft. of continuous glass surface. Contact factory for special units. **Building Codes** vary greatly between States and Counties, and R. Lang Company cannot be held liable for knowing a customer's specific regulations or product application. It is up to the builder/contractor/architect to verify products are within compliance before order is placed.

PACKAGING - All glass skylights are boxed. See **Packaging Chart** located in "Shipping Terms and Conditions" for orders shipping Common Carrier. **NOTE: Recommend a minimum 3/12 roof pitch for proper weeping. Flat roof installation NOT recommended and voids Warranty.**



TRU-FRAME®
A name you can build on.

**OPEN-AIR FLAT GLASS
CURB MOUNT SKYLIGHT**

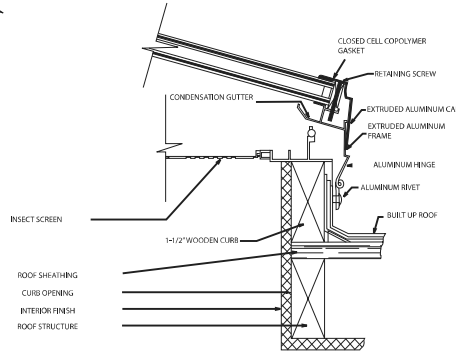
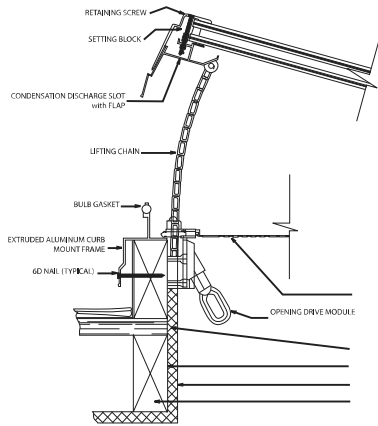

FRAME FINISH

- = Mill Finish
- = Bronze Paint

(Special Orders Only)

* All other Tru-Frame® custom colors are available – Call for quote

GLASS OPTIONS

- Single
- L = Laminated (Clear)

Insulated (Tempered/Laminated)

- CL = Clear
- BL = Bronze
- EL = Low-E2
- SL = Solar Cool Bronze

**MILL FINISH
LIST PRICE**

PART NO.	WOOD CURB OUTSIDE DIMENSION	SINGLE (L)	INSULATED (CL)	INSULATED (BL)	INSULATED (EL)	INSULATED (SL)
LOG2424	25-1/2" x 25-1/2"	\$738.50	\$860.50	\$875.00	\$894.00	\$959.00
LOG2436	25-1/2" x 37-1/2"	\$852.00	\$1,118.00	\$1,142.00	\$1,185.00	\$1,334.00
LOG2448	25-1/2" x 49-1/2"	\$1,214.50	\$1,290.50	\$1,328.00	\$1,397.00	\$1,622.00
LOG2472	25-1/2" x 73-1/2"	\$1,400.50	\$1,898.00	\$1,944.00	\$2,046.50	\$2,397.50
LOG2496	25-1/2" x 97-1/2"	\$1,611.50	\$2,310.00	\$2,109.00	\$2,460.50	\$2,968.50
LOG3636	37-1/2" x 37-1/2"	\$1,217.00	\$1,484.50	\$1,916.50	\$1,583.50	\$1,796.50
LOG3648	37-1/2" x 49-1/2"	\$1,360.00	\$1,705.00	\$1,751.50	\$1,952.00	\$2,298.50
LOG4848	49-1/2" x 49-1/2"	\$1,534.50	\$1,984.50	\$2,002.50	\$2,238.00	\$2,393.00

**BRONZE FINISH
LIST PRICE**

PART NO.	WOOD CURB OUTSIDE DIMENSION	SINGLE (L)	INSULATED (CL)	INSULATED (BL)	INSULATED (EL)	INSULATED (SL)
LOG2424	25-1/2" x 25-1/2"	\$771.00	\$898.00	\$912.00	\$934.00	\$967.00
LOG2436	25-1/2" x 37-1/2"	\$893.00	\$1,163.00	\$1,192.00	\$1,231.50	\$1,342.50
LOG2448	25-1/2" x 49-1/2"	\$1,007.50	\$1,347.50	\$1,386.50	\$1,448.50	\$1,626.50
LOG2472	25-1/2" x 73-1/2"	\$1,478.00	\$1,962.50	\$2,016.50	\$2,119.50	\$2,401.00
LOG2496	25-1/2" x 97-1/2"	\$1,686.50	\$2,327.50	\$2,393.00	\$2,546.00	\$2,975.50
LOG3636	37-1/2" x 37-1/2"	\$1,271.00	\$1,539.00	\$1,572.50	\$1,634.50	\$1,805.50
LOG3648	37-1/2" x 49-1/2"	\$1,418.00	\$1,938.00	\$1,991.50	\$2,013.50	\$2,309.50
LOG4848	49-1/2" x 49-1/2"	\$1,620.50	\$2,079.50	\$2,106.00	\$2,306.00	\$2,735.50

All Open-Air® Skylights listed above are **NON-STOCK STANDARD** sizes. **Specials** are available, see Special Order Instruction Sheet for this section. **SPECIAL SKYLIGHTS CANNOT BE CANCELLED OR RETURNED.** Outside curb dimension **DOES NOT** include flashing. Glass skylights cannot be manufactured with more than 16 sq. ft. of continuous surface. **Building Codes** vary greatly between States and Counties, and R. Lang Company **cannot be held liable** for knowing a customer's specific regulations or product application. It is up to the **builder/contractor/architect** to verify products are within compliance before order is placed.. **ALL OPEN AIR SKYLIGHTS** are equipped with a removable screen and operator pole which will extend from 6 to 10 feet.

THE STANDARD HINGE LOCATION for rectangular Open-Air Skylights is on the short side. If a unit is to be hinged on the long side, this must be specified when ordering. Add \$60.00 list to prices above for specific hinge location.

ELECTRIC OPERATOR - An electrically operated, 24-volt DC motor can be substituted for the manual operator. Contact factory for pricing/information.

PACKAGING - All Glass skylights are boxed. See Packaging Chart located in "Shipping Terms and Conditions" for orders shipping Common Carrier.

NOTE: Recommend a minimum 3/12 roof pitch for proper weeping. Flat roof installation **NOT** recommended and voids Warranty.

CURB MOUNT SKYLIGHT DIMENSION REFERENCE

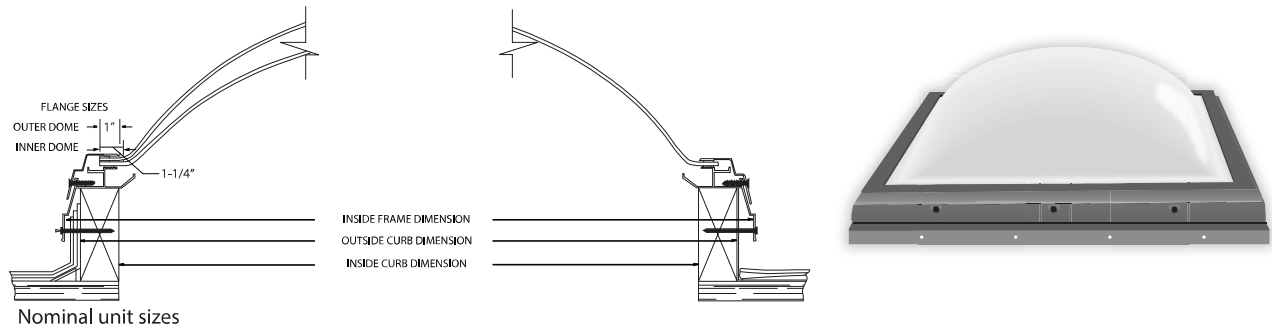

Nominal unit sizes

NORMAL DOME SIZE FLANGE-TO-FLANGE	"A" WOODEN CURB INSIDE DIMENSION	"B" WOODEN CURB OUTSIDE DIMENSION	"C" INSIDE SKYLIGHT FRAME DIMENSION	DOME RISE
16" x 16"	14-1/2" x 14-1/2"	17-1/2" x 17-1/2"	18-3/4" x 18-3/4"	4"
16" x 24"	14-1/2" x 22-1/2"	17-1/2" x 25-1/2"	18-3/4" x 26-3/4"	4"
16" x 32"	14-1/2" x 30-1/2"	17-1/2" x 33-1/2"	18-3/4" x 34-3/4"	4"
16" x 48"	14-1/2" x 46-1/2"	17-1/2" x 49-1/2"	18-3/4" x 50-3/4"	4"
24" x 24"	22-1/2" x 22-1/2"	25-1/2" x 25-1/2"	26-3/4" x 26-3/4"	6"
24" x 32"	22-1/2" x 30-1/2"	25-1/2" x 33-1/2"	26-3/4" x 34-3/4"	6"
24" x 36"	22-1/2" x 34-1/2"	25-1/2" x 37-1/2"	26-3/4" x 38-3/4"	6"
24" x 48"	22-1/2" x 46-1/2"	25-1/2" x 49-1/2"	26-3/4" x 50-3/4"	6"
24" x 96"	22-1/2" x 94-1/2"	25-1/2" x 97-1/2"	26-3/4" x 98-3/4"	6"
32" x 32"	30-1/2" x 30-1/2"	33-1/2" x 33-1/2"	34-3/4" x 34-3/4"	6"
32" x 48"	30-1/2" x 46-1/2"	33-1/2" x 49-1/2"	34-3/4" x 50-3/4"	6"
32" x 72"	30-1/2" x 70-1/2"	33-1/2" x 73-1/2"	34-3/4" x 74-3/4"	8"
32" x 96"	30-1/2" x 94-1/2"	33-1/2" x 97-1/2"	34-3/4" x 98-3/4"	8"
36" x 36"	34-1/2" x 34-1/2"	37-1/2" x 37-1/2"	38-3/4" x 38-3/4"	7"
36" x 48"	34-1/2" x 46-1/2"	37-1/2" x 49-1/2"	38-3/4" x 50-3/4"	7"
36" x 72"	34-1/2" x 70-1/2"	37-1/2" x 73-1/2"	38-3/4" x 74-3/4"	8"
36" x 96"	34-1/2" x 94-1/2"	37-1/2" x 97-1/2"	38-3/4" x 98-3/4"	8"
48" x 48"	46-1/2" x 46-1/2"	49-1/2" x 49-1/2"	50-3/4" x 50-3/4"	8"
48" x 72"	46-1/2" x 70-1/2"	49-1/2" x 73-1/2"	50-3/4" x 74-3/4"	8"
48" x 96"	46-1/2" x 94-1/2"	49-1/2" x 97-1/2"	50-3/4" x 98-3/4"	10"

SPECIFICATIONS:

1. MATERIALS

- 2.1 **ALLOYS** — Aluminum shall be commercial quality, free from defects impairing strength and durability. All extruded aluminum sections shall be 6063 T-5 alloy and temper.
- 2.2 **FRAME MEMBERS** — Main frame and cap shall be extruded aluminum and of sufficient strength to perform as designed. Main frame shall be at least 3" x 2-7/8". Cap frame shall be 2" x 1-3/4".
- 2.3 **DOMES** — All domes shall be formed from acrylic sheet in proper thickness, either clear or colored. All acrylic shall be an approved plastic as defined in Section 5202 of the Uniform Building Code.
- 2.4 **WEATHER SEAL** — All members shall be weather sealed with a closed-cell polymer foam gasket which is coated on both sides with a pressure sensitive acrylic adhesive. This gasket shall meet or exceed AAMA #810.1-1977, and perform in such a manner as to withstand environmental break down and maintain an effective weather seal.

2. CONSTRUCTION

- 3.1 **ASSEMBLY** — Skylights shall be assembled in a secure and workmanlike manner. The frame members shall be of mitered construction, joined at each corner with a heliarc weld. One or two domes shall be separated by a weather seal, and clamped in place firmly by cap frame. The cap frame shall be anchored to the gutter frame with plated #8 x 1" Phillips flat head sheet metal screws at 12" OC maximum.

3. FINISH

- 4.1 **ALUMINUM** — All frame members shall be mill finish or commercial bronze paint, and shall meet standard quality specifications of the industry.



TRU-FRAME®
A name you can build on.

TRU-FRAME® REPLACEMENT DOMES

For use with LC & LO Models Only

(Replacement Domes for LLA Models - The Outside Wood Curb Size is same Dimension as the Dome Flange-to-Flange Size)

PART NO.	DESCRIPTION	DOMES RISE	SINGLE DOME	DOUBLE DOME
LR1616	16" x 16" - Acrylic Replacement Dome Only	5"	\$77.00	\$147.00
LR1624	16" x 24" - Acrylic Replacement Dome Only	5"	\$111.50	\$213.50
LR1632	16" x 32" - Acrylic Replacement Dome Only	5"	\$122.50	\$235.50
LR1648	16" x 48" - Acrylic Replacement Dome Only	5"	\$144.50	\$276.50
LR2424	24" x 24" - Acrylic Replacement Dome Only	6"	\$105.50	\$199.50
LR2432	24" x 32" - Acrylic Replacement Dome Only	6"	\$139.50	\$263.50
LR2436	24" x 36" - Acrylic Replacement Dome Only	6"	\$158.50	\$301.00
LR2448	24" x 48" - Acrylic Replacement Dome Only	6"	\$209.00	\$396.50
LR2472	24" x 72" - Acrylic Replacement Dome Only	8"	\$245.00	\$466.00
LR2496	24" x 96" - Acrylic Replacement Dome Only	10"	\$323.50	\$616.00
LR3232	32" x 32" - Acrylic Replacement Dome Only	6"	\$150.00	\$284.50
LR3248	32" x 48" - Acrylic Replacement Dome Only	6"	\$209.00	\$396.50
LR3272	32" x 72" - Acrylic Replacement Dome Only	8"	\$298.00	\$568.00
LR3296	32" x 96" - Acrylic Replacement Dome Only	10"	\$374.00	\$710.00
LR3636	36" x 36" - Acrylic Replacement Dome Only	7"	\$245.00	\$466.00
LR3648	36" x 48" - Acrylic Replacement Dome Only	7"	\$258.00	\$492.50
LR3672	36" x 72" - Acrylic Replacement Dome Only	10"	\$399.50	\$764.00
LR4848	48" x 48" - Acrylic Replacement Dome Only	8"	\$302.00	\$575.00
LR4872	48" x 72" - Acrylic Replacement Dome Only	11"	\$531.00	\$1,014.00
LR4896	48" x 96" - Acrylic Replacement Dome Only	11"	\$652.00	\$1,244.00

SPECIALS: Specials are available. Add \$40.00 list to next largest size. **CUSTOM UNITS CANNOT BE CANCELLED OR RETURNED.** Building Codes vary greatly between States and Counties, and R. Lang Company cannot be held liable for knowing a customer's specific regulations or product application. It is up to the builder/contractor/architect to verify products are within compliance before order is placed.

NOTE: Due to the thermo-forming process, domes 48" or larger will have some shrinkage which can be eliminated by applying downward pressure when installing.

Nominal "call out" size = Actual dome size or flange-to-flange dimension.

All replacement domes are available in single or double dome configuration. Replacement domes are designed for use with Tru-Frame® skylights. All replacement domes are polywrapped – See [Packaging Chart](#) located in "Shipping Terms and Conditions" to calculate Packaging Fees for orders shipping Common Carrier.

Dome colors available are CLEAR, WHITE or BRONZE. Specify dome color(s) as follows:

DOUBLE DOME

CC = CLEAR over CLEAR
BC = BRONZE over CLEAR
WC = WHITE over CLEAR

SINGLE DOME

C = CLEAR
B = BRONZE
W = WHITE

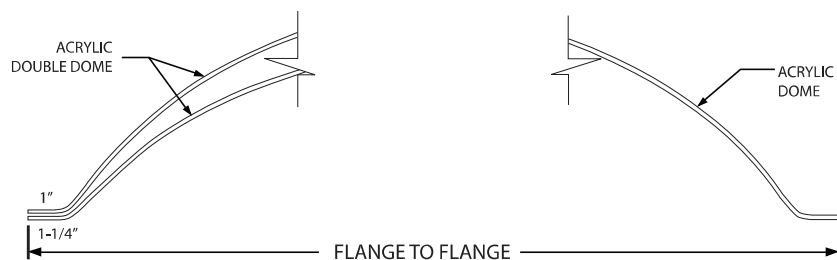

TRU-FRAME® SKYLIGHT FLASHING

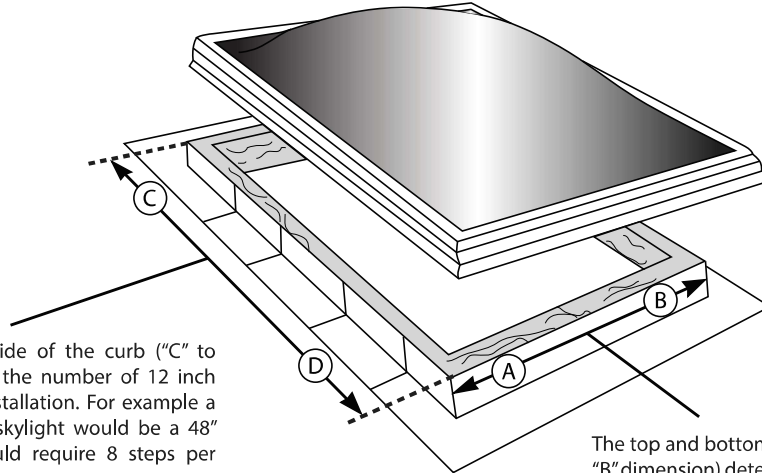

The pitch or down-slope side of the curb ("C" to "D" dimension) determines the number of 12 inch step flashing needed for installation. For example a Tru-Frame® LC2448 model skylight would be a 48" pitch down-slope and would require 8 steps per installation.

The top and bottom measurement of the curb ("A" to "B" dimension) determines the size of the flashing. For example, a Tru-Frame® LC2448 model skylight would require a 24" saddle flashing kit to fit an outside curb 25 1/2".

SKYLIGHT PART NO.	WOOD CURB OUTSIDE DIMENSION	SADDLE FLASHING ONE PAIR MODEL NO.	STEPS REQUIRED
LC1616	17-1/2" x 17-1/2"	LF16	2
LC1624	17-1/2" x 25-1/2"	LF16	4
LC1632	17-1/2" x 33-1/2"	LF16	6
LC1648	17-1/2" x 49-1/2"	LF16	8
LC2424	25-1/2" x 25-1/2"	LF24	4
LC2432	25-1/2" x 33-1/2"	LF24	6
LC2436	25-1/2" x 37-1/2"	LF24	6
LC2448	25-1/2" x 49-1/2"	LF24	8
LC2472	25-1/2" x 73-1/2"	LF24	12
LC2496	25-1/2" x 97-1/2"	LF24	16
LC3232	33-1/2" x 33-1/2"	LF32	6
LC3248	33-1/2" x 49-1/2"	LF32	8
LC3272	33-1/2" x 73-1/2"	LF32	12
LC3296	33-1/2" x 97-1/2"	LF32	16
LC3636	37-1/2" x 37-1/2"	LF36	6
LC3648	37-1/2" x 49-1/2"	LF36	8
LC3672	37-1/2" x 73-1/2"	LF36	12
LC3696	37-1/2" x 97-1/2"	LF36	16
LC4848	49-1/2" x 49-1/2"	LF48	8
LC4872	49-1/2" x 73-1/2"	LF48	12
LC4896	49-1/2" x 97-1/2"	LF48	16



TRU-FRAME®
A name you can build on.

TRU-FRAME® FLASHING KITS

PART NO.	DESCRIPTION	WOOD CURB INSIDE DIMENSION	WOOD CURB OUTSIDE DIMENSION	QTY PER PACKAGE	LIST PRICE
LF16	16" T&B Galvanized Saddle Flashing	14-1/2"	17-1/2"	1 Pair	\$101.00
LF24	24" T&B Galvanized Saddle Flashing	22-1/2"	25-1/2"	1 Pair	\$114.00
LF32	32" T&B Galvanized Saddle Flashing	30-1/2"	33-1/2"	1 Pair	\$127.50
LF36	36" T&B Galvanized Saddle Flashing	34-1/2"	37-1/2"	1 Pair	\$134.50
LF48	48" T&B Galvanized Saddle Flashing	46-1/2"	49-1/2"	1 Pair	\$152.00
LF64	64" T&B Galvanized Saddle Flashing	62-1/2"	65-1/2"	1 Pair	\$222.00
LF72	72" T&B Galvanized Saddle Flashing	70-1/2"	73-1/2"	1 Pair	\$233.50
LF96	96" T&B Galvanized Saddle Flashing	94-1/2"	97-1/2"	1 Pair	\$292.00
LFS12	12" x 12" Galvanized Step Flashing	-	-	10 Each	\$71.50

SPECIALS: Add \$30.00 list to next largest size
PACKAGING: Saddle Flashing is packed (1) pair per carton. Step flashing is packed ten (10) pieces per carton.
 No broken cartons.

SKYLIGHT COMPONENTS

MODEL NO.	ITEM NAME	DESCRIPTION	LIST PRICE
LE1003	WLS Electric Operator System	Installs on the R. Lang manual operator. Includes wall switch.	\$1,500.00
LE1003##	WLS Electric Operator Cover	Cover for LE1003 operator - (Sold separately from WLS Operator).	\$35.00
LE1004	HS Electric Operator System	Replaces R. Lang operator. Wall switch is NOT included (Available separately).	\$1,750.00
LE1004##	HS Electric Operator Cover	Cover for LE1004 operator - (Sold separately from HS Operator).	\$45.00
LE1005	Electric Operator Wall Switch	For use with the LE1004 HS Operator.	\$375.00
LE1006	Remote for Electric Operator	For use with the LE1003 and LE1004 operators.	\$450.00
LH1500	Skylight Operator Pole		\$85.00
LH1510	Skylight Operator Eyelet		\$18.00
LH1510BR	Skylight Operator Eyelet Bronze		\$23.00
LH1510WH	Skylight Operator Eyelet White		\$23.00
LM1110	1/8" x 1/2" x 100 Ft Glaze Tape 1-Sided - (Price per Foot)		\$0.65
LM1112	1/8" x 1/2" x 100 Ft Glaze Tape 2-Sided - (Price per Foot)		\$0.65

- Brown plastic (BR), Gray (GR), White (WH)

ELECTRIC MOTOR REQUIRED

NOMINAL	ACRYLIC	GLASS
2424	WLS	WLS
2432	WLS	WLS
2436	WLS	WLS
2448	WLS	WLS
2472	WLS	HS
2496	WLS	HS
3232	WLS	WLS
3236	WLS	WLS
3248	WLS	WLS

NOMINAL	ACRYLIC	GLASS
3272	WLS	HS
3296	WLS	HS
3636	WLS	WLS
3648	WLS	HS
3672	WLS	N/A
3696	WLS	N/A
4848	WLS	HS
4872	WLS	N/A
4896	HS	N/A

Note: "nominal" refers to the 4 digit part number on all open-air skylights. "WLS" (light load) and "HS" (heavy load) are the type operators.
 For example, pg 59 a LOG2424 could use a "WLS" for Acrylic or Glass skylight.



TRU-FRAME®
A name you can build on.

"L" Series Skylight (Fixed & Operable)

Fax Number: 888-526-4329

ORDER QUOTE (Check One)

DATE: _____

DEALER: _____

JOB NAME/PO#: _____

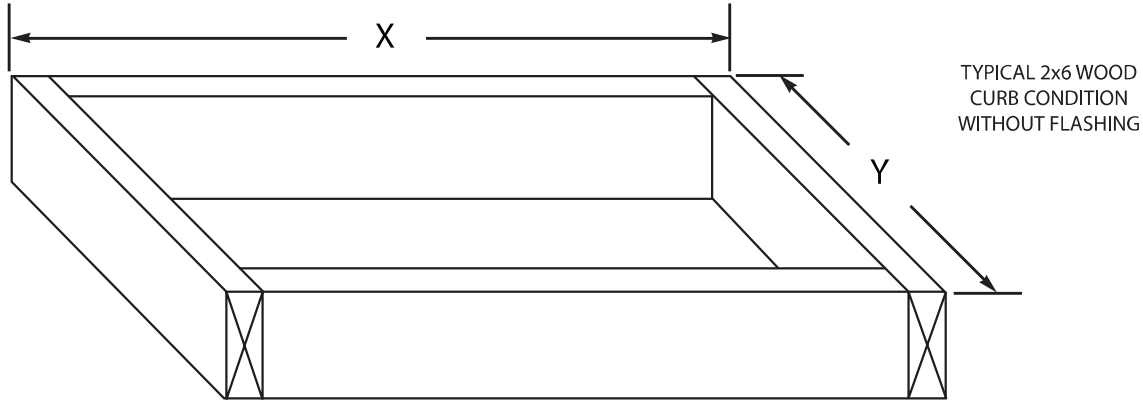

SPECIAL SKYLIGHT DIMENSIONS
(Fill in blanks)

"X" OUTSIDE CURB DIMENSION: _____ " (To the nearest 1/8")

"Y" OUTSIDE CURB DIMENSION: _____ " (To the nearest 1/8")

SPECIAL SKYLIGHT OPTIONS
(Check one selection for each option)

SKYLIGHT MODEL: Fixed (LC) Open Air (LO) Hinge Long Side Hinge Short Side

FRAME FINISH: Mill Finish Bronze Painted Other Finishes Available (Call for Quote)

DOMES OPTIONS:
Single Dome: Clear White Bronze
Double Domes: Clear/Clear White/Clear Bronze/Clear

GLASS OPTIONS:
Single (Laminated): Single Clear Laminated Other
Insulated (Tempered/Laminated): Clear/Clear Bronze/Clear Low-E2/Clear Solar Cool Bronze/Clear

NEXT LARGEST STANDARD SIZE SKYLIGHT (LIST PRICE):	\$ _____
DEDUCT DISCOUNT:	- \$ _____
SPECIAL SIZE SKYLIGHT SET-UP CHARGE (\$30.00 NET ADD):	+ \$ _____
TOTAL PRICE:	\$ _____

**We recommend a minimum 3/12 roof pitch for proper weeping.
Flat roof installation NOT recommended and will void the warranty.**



TRU-FRAME®
A name you can build on.

ORDER QUOTE (Check One)

LT & LTR Series Skylight
Fax Number: 888-526-4329

DATE: _____

DEALER: _____

JOB NAME/PO#: _____

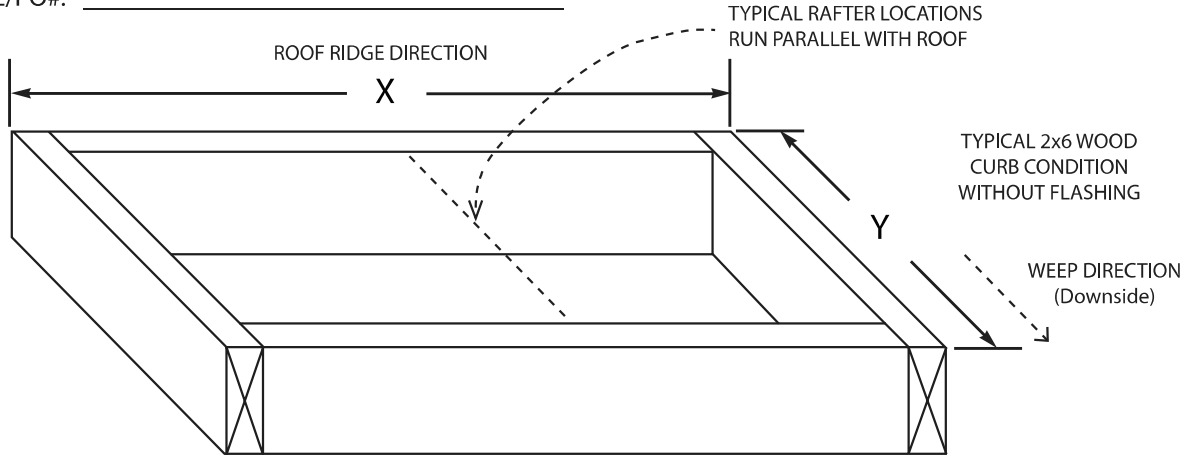

SPECIAL CUSTOM SKYLIGHT DIMENSIONS
(Fill in blanks)

"X" OUTSIDE CURB DIMENSION: _____ (To the nearest 1/8")

"Y" OUTSIDE CURB DIMENSION: _____ (To the nearest 1/8")

#-RAFTERS: _____

SPECIAL SKYLIGHT OPTIONS
(Check one selection for each option)

SKYLIGHT MODEL: Fixed Open Air Hinge Long Side Hinge Short Side
 Electric

FRAME FINISH: Mill Finish Bronze Painted Other Finishes Available (Call for Quote)

DOMES OPTIONS:
Single Dome: Clear White Bronze
Double Domes: Clear/Clear White/Clear Bronze/Clear Other:

GLASS OPTIONS:
Single (Laminated): Clear Other:
Insulated (Tempered/Laminated): Clear/Clear Bronze/Clear Low-E2/Clear Other:

Note: Glass skylights that exceed 16 square feet surface require rafters.

SPECIAL INSTRUCTIONS: _____



TRU-FRAME®
A name you can build on.



PAN HEAD SCREWS

PART NO.	DESCRIPTION	FINISH	PCS. PER PKG.	LIST (EA.)	LIST (PKG.)
M390604BL	#6 x 1/4 Phillips Pan Head SMS Black ZI	Black Zinc	100	\$0.080	\$8.00
M390604WH	#6 x 1/4 Phillips Pan Head SMS White ZI	White Zinc	100	\$0.080	\$8.00
M390604ZI	#6 x 1/4 Phillips Pan Head SMS Zinc	Zinc Plated	100	\$0.064	\$6.40
M390606BL	#6 x 3/8 Phillips Pan Head SMS Black ZI	Black Zinc	100	\$0.096	\$9.60
M390606SS	#6 x 3/8 Phillips Pan Head SMS SS	Stainless Steel	100	\$0.144	\$14.40
M390612ZI	#6 x 3/4 Phillips Pan Head SMS ZI	Black Zinc	100	\$0.064	\$6.40
M390616BL	#6 x 1 Phillips Pan Head SMS Black ZI	Black Zinc	100	\$0.184	\$18.40
M390616SS	#6 x 1 Phillips Pan Head SS	Stainless Steel	100	\$0.230	\$23.00
M390616WH	#6 x 1 Phillips Pan Head White ZI	White Zinc	100	\$0.184	\$18.40
M390616ZI	#6 x 1 Phillips Pan Head Zinc	Zinc Plated	100	\$0.169	\$16.90
M390624ZI	#6 x 1-1/2 Phillips Pan Head SMS ZI	Zinc Plated	100	\$0.073	\$7.30
M390804BL	#6 x 1/4 Phillips Pan Head SMS Black ZI	Black Zinc	100	\$0.252	\$25.20
M390804WH	#6 x 1/4 Phillips Pan Head SMS White ZI	White Zinc	100	\$0.125	\$12.50
M390804ZI	#6 x 1/4 Phillips Pan Head SMS Zinc	Zinc Plated	100	\$0.117	\$11.70
M390812BL	#8 x 3/4 Phillips Pan Head SMS Black ZI	Black Zinc	100	\$0.106	\$10.60
M390812ZI	#8 x 3/4 Phillips Pan Head SMS A ZI	Zinc Plated	100	\$0.095	\$9.50
M391008BL	#10 x 1/2 Phillips Pan SMS BL ZI	Black Zinc	100	\$0.359	\$35.90
M391008WH	#10 x 1/2 Phillips Pan SMS WH ZI	White Zinc	100	\$0.101	\$10.10
M391008ZI	#10 x 1/2 Phillips Pan SMS ZI	Zinc Plated	100	\$0.290	\$29.00
M391016ZI	#10 x 1 Phillips Pan Head SMS A ZI	Zinc Plated	100	\$0.073	\$7.30
M391020ZI	#10 x 1-1/4 Phillips Pan Head SMS A ZI	Zinc Plated	100	\$0.087	\$8.70
M391024ZI	#10 x 1-1/2 Phillips Pan Head SMS A ZI	Zinc Plated	100	\$0.087	\$8.70
M391028ZI	#10 x 1-3/4 Phillips Pan Head SMS A ZI	Zinc Plated	100	\$0.228	\$22.80
M391032ZI	#10 x 2 Phillips Pan Head SMS A ZI	Zinc Plated	100	\$0.421	\$42.10
M491024ZI	#10-24X1 1/2 Phillips Pan Head "F" ZI	Zinc Plated	100	\$0.639	\$63.90
M491028ZI	#10-24X1 3/4 Phillips Pan Head ST "F"	Zinc Plated	100	\$0.920	\$92.00

* Less than standard packaging add 20%



TRU-FRAME®
A name you can build on.



FLAT HEAD SCREWS

PART NO.	DESCRIPTION	FINISH	PCS. PER PKG.	LIST (EA.)	LIST (PKG.)
M370608BL	#6 x 1/2 Phillips Flat Head SMS A Black	Black Oxide	100	\$0.120	\$12.00
M370608SS	#6 x 1/2 Phillips Flat Head SMS SS	Stainless Steel	100	\$0.133	\$13.30
M370608WH	#6 x 1/2 Phillips Flat Head SMS White ZI	Zinc Plated	100	\$0.073	\$7.30
M370612BL	#6 x 3/4 Phillips Flat Head SMS Black ZI	Black Zinc	100	\$0.103	\$10.30
M370612SS	#6 x 3/4 Phillips Flat Head SMS SS	Stainless Steel	100	\$0.142	\$14.20
M370612WH	#6 x 3/4 Phillips Flat Head SMS White ZI	White Zinc	100	\$0.073	\$7.30
M370612ZI	#6 x 3/4 Phillips Flat Head SMS Zinc	Zinc Plated	100	\$0.080	\$8.00
M370616BL	#6 x 1 Phillips Flat Head SMS Black ZI	Black Zinc	100	\$0.167	\$16.70
M370616SS	#6 x 1 Phillips Flat Head SMS SS	Stainless Steel	100	\$0.176	\$17.60
M370616WH	#6 x 1 Phillips Flat Head SMS White ZI	White Zinc	100	\$0.087	\$8.70
M370616ZI	#6 x 1 Phillips Flat Head SMS Zinc	Zinc	100	\$0.083	\$8.30

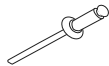

SPECIALITY FASTENERS

PART NO.	DESCRIPTION	FINISH	PCS. PER PKG.	LIST (EA.)	LIST (PKG.)
M480606BW	#6-20 x 3/8 Phillips PanTEK BW	Black	100	\$0.144	\$14.40
M480606DB	#6-20 x 3/8 Phillips PanTEK Musket BR	Bronze	100	\$0.144	\$14.40
M480606ZI	#6-20 x 3/8 Phillips PanTEK ZI	Zinc	100	\$0.111	\$11.10
M491010ZI	#10-24 x 5/8 Phillips Pan Head S/T ZI	Zinc	100	\$0.262	\$26.20
M491012ZI	#10-24 x 3/4 Phillips Pan Head S/T ZI	Zinc	100	\$0.319	\$31.90
M39010ZI	#10 x 3/4 PHIL FLAT TEK U/C ZI	Zinc	100	\$0.528	\$52.80
M961312ZI	#13 x 3/4 Spiral Steel Nail		1 lb.	-	\$18.00
M98ABA42	.125 X 1/8 Aluminum Blind Rivet	Mill	100	\$0.162	\$16.20
M98ABA43	.125 x 3/16 Aluminum Blind Rivet	Mill	100	\$0.179	\$17.90
M98ABA68	ABA68 Blind Rivet	Mill	100	\$0.424	\$42.40
M98ABA68WH	ABA68 Blind Rivet WH	White	100	\$0.543	\$54.30
M501432SS	#14x2 BUTTON TORX TP AB SS	Stainless Steel	100	\$4.235	\$423.50
M501432ZI	#14x2 BUTTON TORX TP AB ZINC	Zinc	100	\$2.42	\$242.00
M501448SS	#14x3 BUTTON TORX TP AB 18-8SS	Stainless Steel	100	\$4.84	\$484.00

* Less than standard packaging ADD 20%.

TRU-FRAME®
A name you can build on.

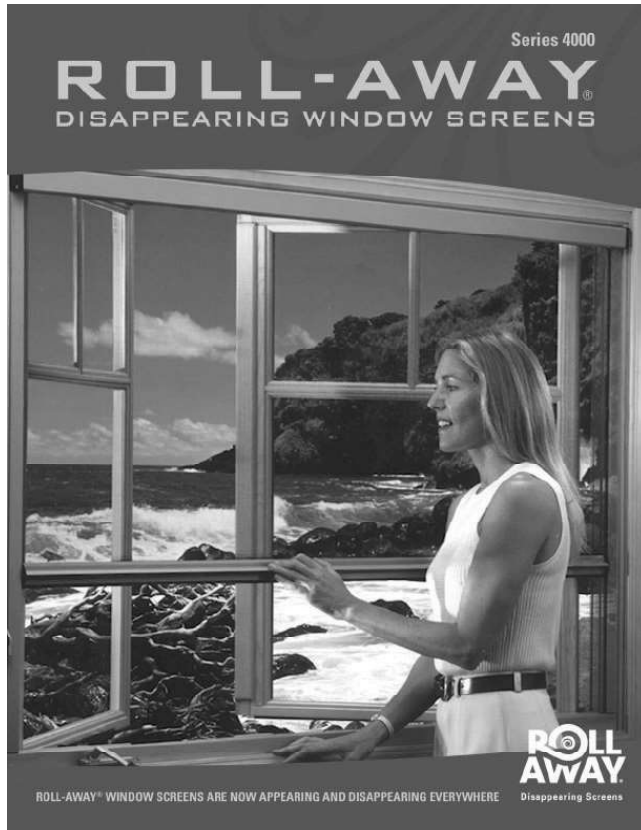

SECTION R

ROLL AWAY® Vintage Series 2000

LIST PRICING

2-3/8" Canopy - Brite Bronze only

WIDTH — All measurements in inches

HEIGHT	18"	24"	30"	36"	42"	48"	60"
	18"	\$212.50	\$220.00	\$233.00	\$254.00	\$267.00	\$276.00
24"	\$231.50	\$242.50	\$254.00	\$269.50	\$277.00	\$288.50	\$358.00
30"	\$239.00	\$252.00	\$267.00	\$277.00	\$290.00	\$305.00	\$378.50
36"	\$245.50	\$260.50	\$276.00	\$288.50	\$305.00	\$317.50	\$398.50
42"	\$252.00	\$271.00	\$284.50	\$303.50	\$312.00	\$334.00	\$416.50
48"	\$260.50	\$277.00	\$295.00	\$311.00	\$330.00	\$346.50	\$435.50
54"	\$269.50	\$287.00	\$306.00	\$321.50	\$342.50	\$361.50	\$454.00
60"	\$276.00	\$295.00	\$312.00	\$335.00	\$352.00	\$377.00	\$473.00
66"	-	\$305.00	\$323.50	\$346.50	\$368.00	\$387.00	\$492.00
72"	-	\$311.00	\$335.00	\$358.00	\$380.50	\$402.50	\$511.00
78"	-	-	\$345.50	\$368.00	\$390.00	\$416.50	-
84"	-	-	\$352.00	\$380.50	\$405.00	-	-

Minimum width = 14" (60" max height)

PART NUMBERS: Example - R21WBZ2424

CLASS	DRAWBAR	FINISH	SCREEN TYPE	SIZE
R	20 = Standard 21 = Reverse	B = Bronze <input checked="" type="checkbox"/> W = White <input type="checkbox"/>	BZ = Brite Bronze	Dimensions from price list

NOTE: Price is determined by using the next largest width and/or height
CUSTOM UNITS CANNOT BE CANCELLED OR RETURNED.

MEASUREMENTS: Give the exact size desired to the nearest 1/16"
Size will be determined by installation location
Manufacturing tolerances are +0", -1/16"

FINISH: Bronze or White Paint
Custom colors available - contact factory

SCREEN: Brite Bronze wire 18 x 14 mesh - 0.009/0.011 thickness (33/36 GA).
No other screen options available on Series 2000 Roll-Away®.

SAMPLES: Bronze Paint - R20 BBZ 0000
White Paint - R20 WH 0000
Samples available \$174.00 List
Samples include finished Wood Frame (see 'Displays & Hand Samples' in front of Catalog)

PACKAGING: See Packaging Chart located in "Shipping Terms and Conditions" to calculate Packaging Fees for orders shipping Common Carrier.



TRU-FRAME®
A name you can build on.

ROLL AWAY® Series 2000 Parts Detail

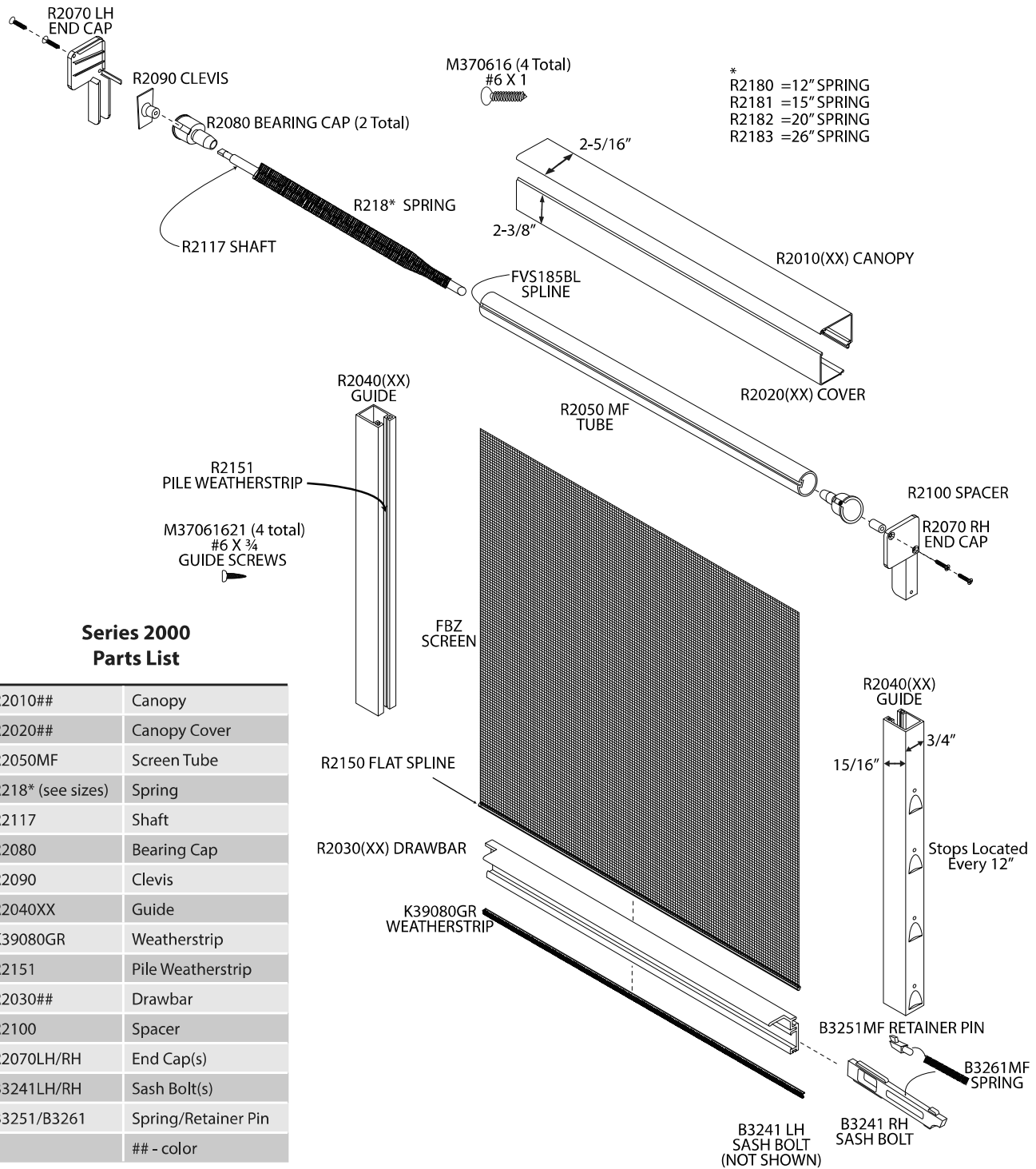

**Series 2000
Parts List**

R2010##	Canopy
R2020##	Canopy Cover
R2050MF	Screen Tube
R218* (see sizes)	Spring
R2117	Shaft
R2080	Bearing Cap
R2090	Clevis
R2040XX	Guide
K39080GR	Weatherstrip
R2151	Pile Weatherstrip
R2030##	Drawbar
R2100	Spacer
R2070LH/RH	End Cap(s)
B3241LH/RH	Sash Bolt(s)
B3251/B3261	Spring/Retainer Pin
## - color	

ROLL AWAY® Contemporary Series 4000



1-7/8" Canopy

WIDTH — All measurements in inches

HEIGHT	18"	24"	30"	36"	42"	48"	60"	72"
	18"	\$160.00	\$169.50	\$178.00	\$185.00	\$195.00	\$204.00	\$284.50
24"	\$167.00	\$175.00	\$183.00	\$193.00	\$203.00	\$208.00	\$292.50	\$315.00
30"	\$173.00	\$181.00	\$192.00	\$202.00	\$206.50	\$218.50	\$302.00	\$327.00
36"	\$178.00	\$186.00	\$197.00	\$205.00	\$217.00	\$222.00	\$308.00	\$338.00
42"	\$183.00	\$193.00	\$204.00	\$212.50	\$221.00	\$228.00	\$318.50	\$346.00
48"	\$192.00	\$202.00	\$208.00	\$218.50	\$227.00	\$240.00	\$329.50	\$353.00
54"	\$196.00	\$205.00	\$217.00	\$222.00	\$236.50	\$246.00	\$341.00	\$364.00
60"	\$203.00	\$212.50	\$221.00	\$228.00	\$241.00	\$251.50	\$348.50	\$376.00
66"	\$206.50	\$218.50	\$227.00	\$237.50	\$248.50	\$257.50	\$360.00	\$385.50
72"	\$217.00	\$221.00	\$234.00	\$246.00	\$256.50	\$266.50	\$370.00	\$396.00
78"	-	\$227.00	\$241.00	\$251.50	\$262.50	\$272.50	\$377.00	-
84"	-	\$231.50	\$246.00	\$257.50	\$268.50	\$280.50	-	-

Minimum width = 14" (60" Max Height)

PART NUMBERS: Example - R41WH012424

CLASS	DRAWBAR	FINISH	SCREEN TYPE	SIZE
R	40 = Standard 41 = Reverse	 = Bronze  = Black  = Desert Sand  = White  = Champagne Beige	01 - 18x14x0.013 Rigid Charcoal Fiberglass	Dimensions from price list

NOTE: Price is determined by using the next largest width and/or height
CUSTOM UNITS CANNOT BE CANCELLED OR RETURNED.

MEASUREMENTS: Give the exact size desired to the nearest 1/16"
Size will be determined by installation location
Manufacturing tolerances are +0", -1/16"

FINISH: Bronze, White, Black, Champagne Beige, Desert Sand
Custom colors are available – Call for quote.

SCREEN: 18 x 14 mesh 0.013 Rigid Charcoal Fiberglass

FEATURES: Low profile designed housing, spring tension adjuster, Mesh Lock™,
Magnetic guide locks, smooth gliding weather-stripped drawbar.

SAMPLES: White - R40WH0100
Bronze - R40BR0100
Samples available \$174.00 List
Samples include finished Wood Frame (see 'Displays & Hand Samples' in front of Catalog)

PACKAGING: See Packaging Chart located in "Shipping Terms and Conditions" to calculate Packaging Fees for orders shipping
Common Carrier.



TRU-FRAME®
A name you can build on.

ROLL AWAY® Series 4000 Parts Detail

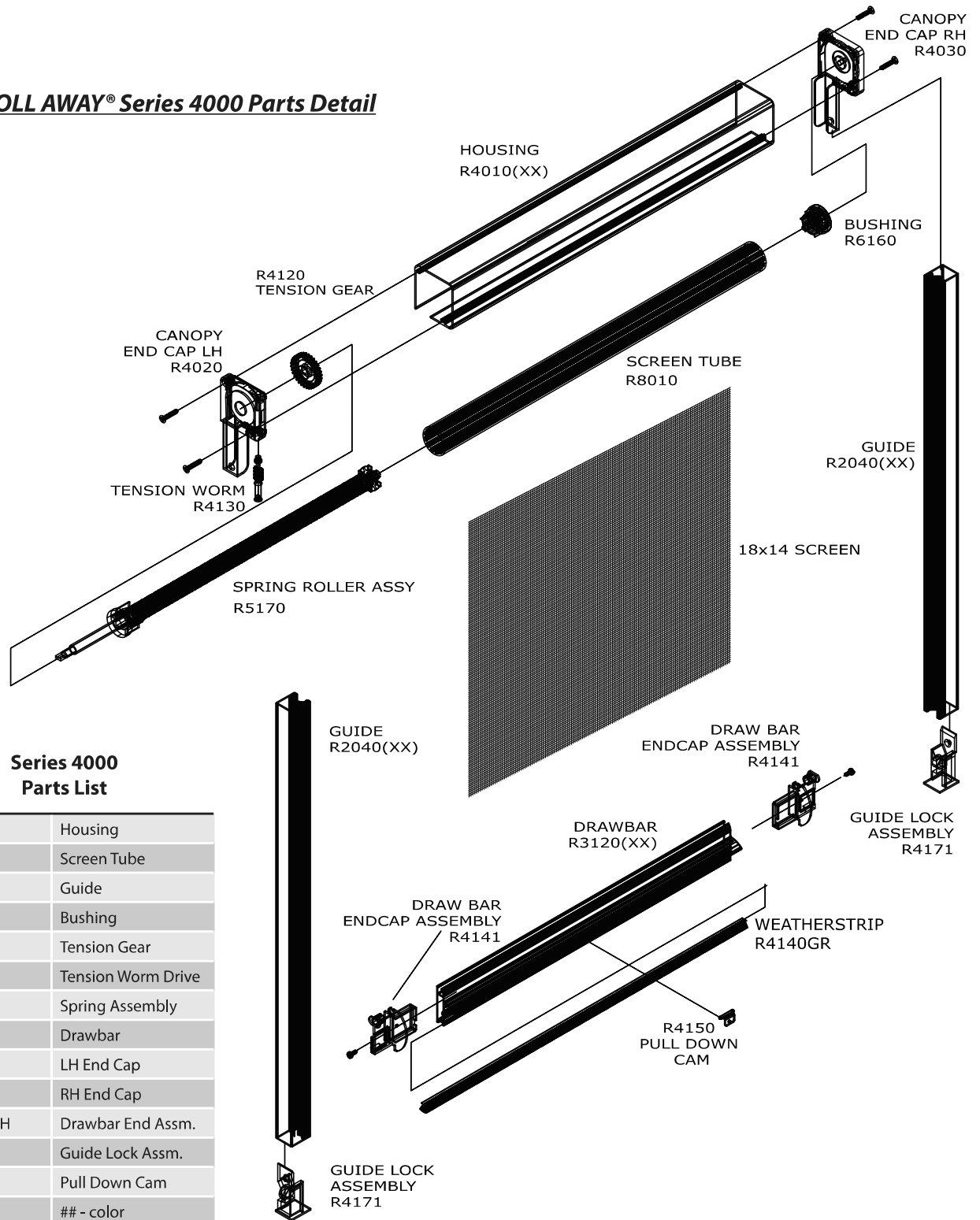

**Series 4000
Parts List**

R4010##	Housing
R8010	Screen Tube
R2040XX	Guide
R6160	Bushing
R4120	Tension Gear
R4130	Tension Worm Drive
R5170	Spring Assembly
R3120##	Drawbar
R4020LH	LH End Cap
R4030RH	RH End Cap
R4141LH/RH	Drawbar End Assm.
R4171	Guide Lock Assm.
R4150	Pull Down Cam
##	- color

ROLL AWAY® Series 6000 Inside Mount

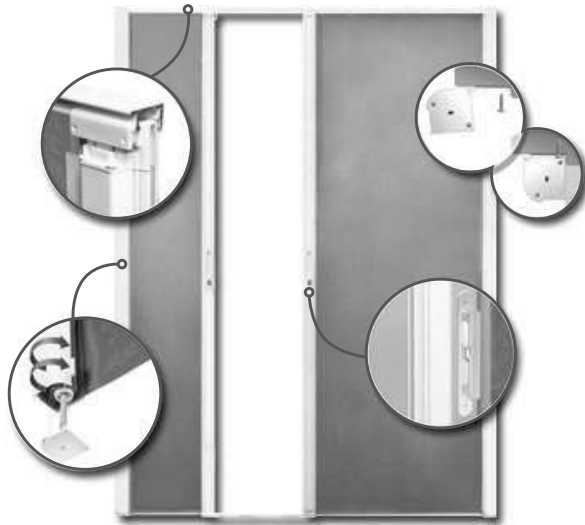

ROLL AWAY®
Disappearing Screen Door

- 1-7/8" Rounded Housing
- 18 x 14 Stiff Charcoal Fiber
- Die Cast Auto-Latch™ handle set
- Best screen Solution for French Doors
- Custom colors available
- Installs inside the jamb

Assembled — Inside Mount

LIST PRICE

Model	Description	Dimensions	Price
R6000##F36	Single Screen Door	Up to 36" x 82"	\$410.00
R6001##F36	Single Screen Door	Up to 36" x 96"	\$445.00
R6050##F72	French Door Set	Up to 72" x 82"	\$842.50
R6051##F72	French Door Set	Up to 72" x 96"	\$935.50

ORDERING: The doors above are made to order and require opening measurements to the nearest 1/16". Single doors must be designated as "RH" (housing on right, rolls from right to left as viewed from the outside looking in) or "LH" for left to right. Specify French Door handing as OX or XO ("X" represents active door).

KD Kit — Inside Mount

Model	Description	Dimensions	Price
R6000##K36	Single Screen Door	Up to 36" x 82"	\$379.00
R6001##K36	Single Screen Door	Up to 36" x 96"	\$413.50
R6050##K72	French Door Set	Up to 72" x 82"	\$766.00
R6051##K72	French Door Set	Up to 72" x 96"	\$859.50

Roll-Away® Series 6000 KD doors are furnished oversize and require fabrication for final assembly.

Model	Description	Dimensions	Price
R600WHS MPL	Single Door Sample with Frame	16" x 20"	\$213.50
R605WHS MPL	French Door Sample with Frame	28.5" x 20"	\$299.00

FINISHES: White (□), Champagne Beige (■), Bronze (■), Black (■), Desert Sand (■)

SCREEN: Roll-Away® Doors are screened with 18 x 14 Stiff Charcoal Fiber.

CUSTOM UNITS CANNOT BE CANCELLED OR RETURNED.

PACKAGING: See [Packaging Chart](#) located in "Shipping Terms and Conditions" to calculate Packaging Fees for Common Carrier orders.

TRU-FRAME®
A name you can build on.

ROLL AWAY® 6000
Inside Mount

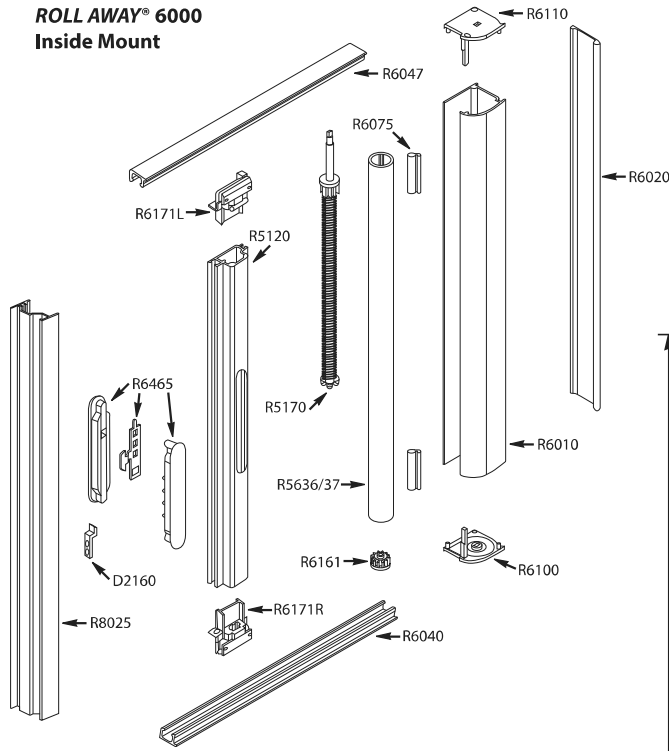

Series 6000 Inside Mount
Parts List

R5120##	Drawbar
R5636MF	Tube with Screen 82"
R5637MF	Tube with Screen 96"
R5170	Spring Roller Assembly
R8025##	Closer
D2160	Stainless Steel Strike & Screw Assembly
R6465BL/WH	Handle Assembly with Strike
R6010##	Housing
R6020##	Hinge
R6040##	Sill Track
R6047##	Head Track
R6075BL/WH	PVC Cushion
R6110BL/WH	Housing End Cap - LH
R6100BL/WH	Housing End Cap - RH
R6161BL/WH	Bushing with Pin
R6171 (BL/WH)L	Drawbar End Cap Assembly - LH
R6171 (BL/WH)R	Drawbar End Cap Assembly - RH
##	- Door color

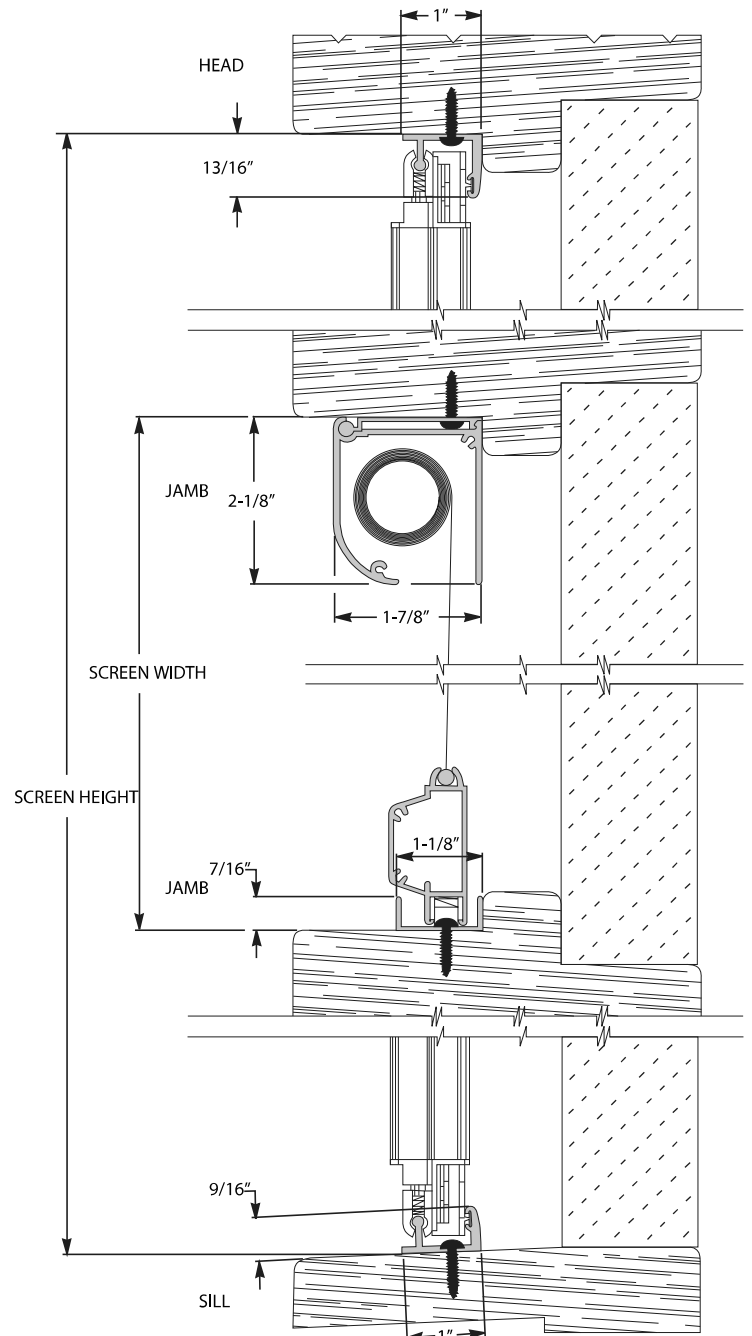

ROLL AWAY® Series 6500 Surface Mount

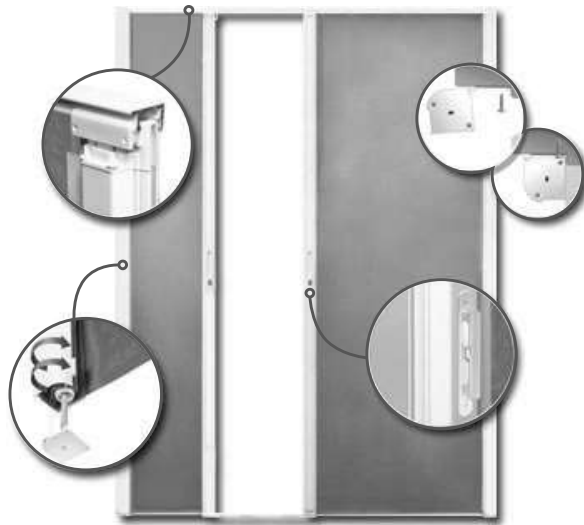

ROLL AWAY®
Disappearing Screen Door

- 1-7/8" Rounded Housing
- 18 x 14 Stiff Charcoal Fiber
- Die Cast Auto-Latch™ handle set
- Best screen Solution for French Doors
- Custom colors available
- Installs on surface of door opening

Assembled — Surface Mount

LIST PRICE

Product Code	Description	Dimensions	Price
R6500##F36	Single Screen Door	Up to 36" x 82"	\$417.50
R6501##F36	Single Screen Door	Up to 36" x 96"	\$452.50
R6550##F72	French Door Set	Up to 72" x 82"	\$858.50
R6551##F72	French Door Set	Up to 72" x 96"	\$951.00

ORDERING: The doors above are made to order and require opening measurements to the nearest 1/16". Single doors must be designated as "RH" (housing on right, rolls from right to left as viewed from the outside looking in) or "LH" for left to right. Specify French Door handing as OX or XO ("X" represents active door).

KD Kit — Surface Mount

Product Code	Description	Dimensions	Price
R6500##K36	Single Screen Door	Up to 36" x 82"	\$388.00
R6501##K36	Single Screen Door	Up to 36" x 96"	\$422.00
R6550##K72	French Door Set	Up to 72" x 82"	\$782.50
R6551##K72	French Door Set	Up to 72" x 96"	\$874.50

Roll-Away® Series 6500 KD doors are furnished oversize and require fabrication for final assembly.

Product Code	Description	Dimensions	Price
R650WHSMP	Single Door Sample with Frame	16" x 20"	\$213.00
R655WHSMP	French Door Sample with Frame	28.5" x 20"	\$299.00

FINISHES: White (□), Champagne Beige (■), Bronze (■), Black (■), Desert Sand (■)

SCREEN: Roll-Away® Doors are screened with 18 x 14 Stiff Charcoal Fiber

CUSTOM UNITS CANNOT BE CANCELLED OR RETURNED.

PACKAGING: See [Packaging Chart](#) located in "Shipping Terms and Conditions" to calculate Packaging Fees for Common Carrier orders.

TRU-FRAME®
A name you can build on.

ROLL AWAY® 6500
Surface Mount

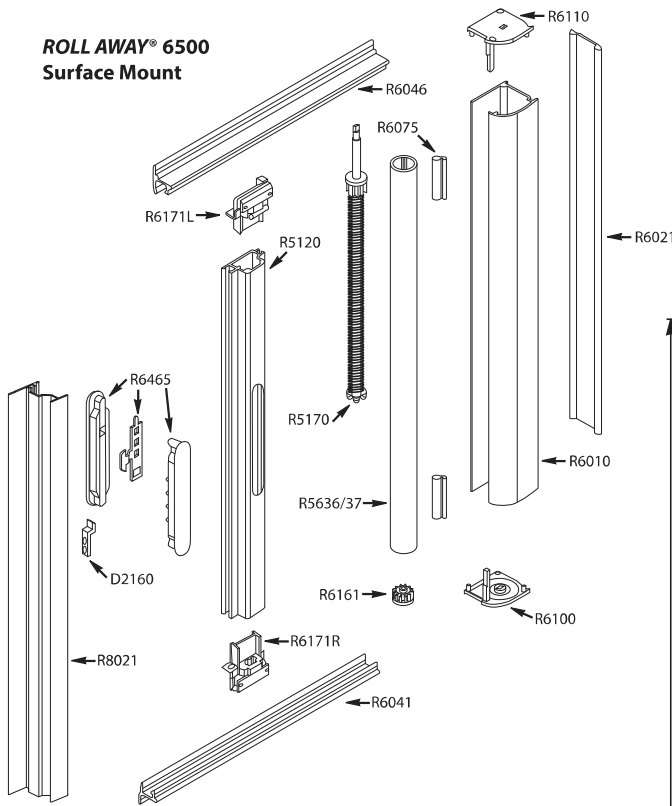

Series 6500 Surface Mount
Parts List

R5120##	Drawbar
R5636MF	Tube with Screen 82"
R5637MF	Tube with Screen 96"
R5170	Spring Roller Assembly
R8021##	Facemount Closer
D2160	Stainless Steel Strike & Screw Assm.
R6465BL/WH	Handle Assembly with Strike
R6010##	Housing
R6021##	Surface Mount Hinge
R6041##	Sill Track
R6046##	Head Track
R6075BL/WH	PVC Cushion
R6110BL/WH	Housing End Cap - LH
R6100BL/WH	Housing End Cap - RH
R6161BL/WH	Bushing with Pan
R6171(BL/WH)L	Drawbar End Cap Assembly - LH
R6171(BL/WH)R	Drawbar End Cap Assembly - RH
##	- Door color

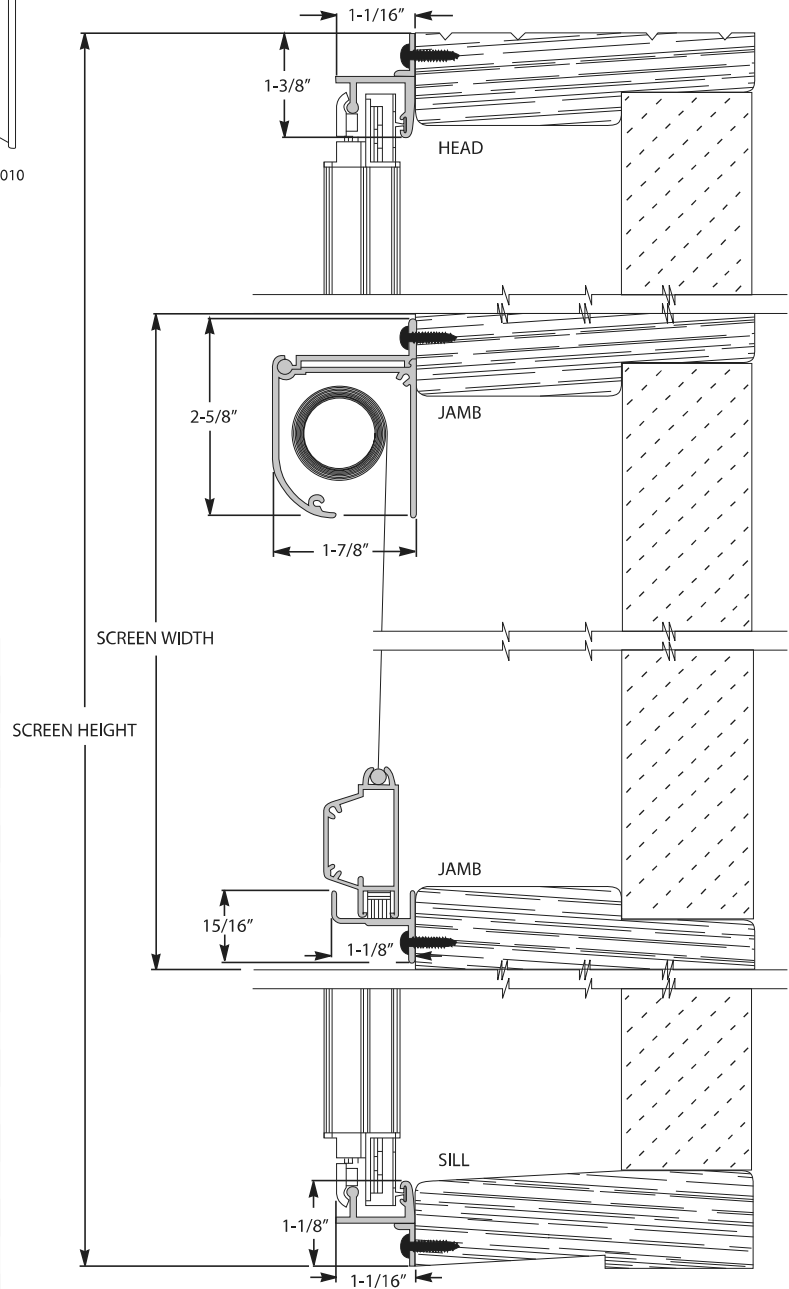

ROLL AWAY[®] Series 7000 Inside Mount

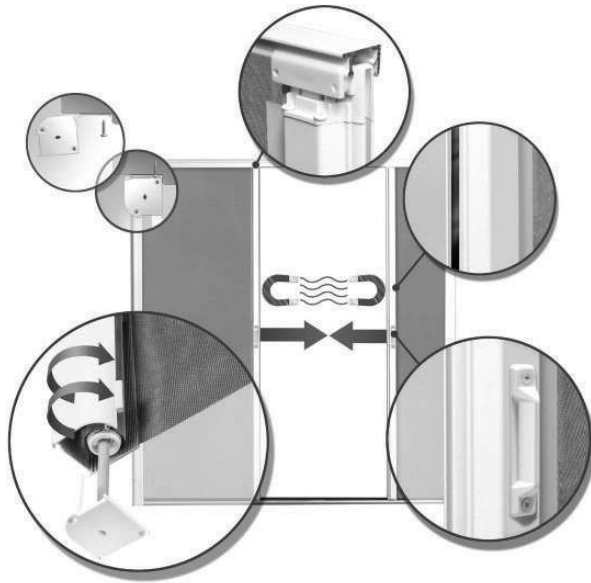

ROLL AWAY[®]
Disappearing Screen Door
With MAGNALOCK[™] SEAL &
Easy-To-Grasp Handle

- 1-7/8" Rounded Housing
- 18 x 14 Stiff Charcoal Fiber
- Best screen Solution for French Doors
- Custom colors available
- Easy-To-Grasp Handle
- Magnalock[™] Seal
- Installs inside the jamb

Assembled — Inside Mount

LIST PRICE

R7000##F36	Single Screen Door	Up to 36" x 82"	\$404.50
R7001##F36	Single Screen Door	Up to 36" x 96"	\$439.00
R7050##F72	French Door Set	Up to 72" x 82"	\$831.00
R7051##F72	French Door Set	Up to 72" x 96"	\$922.00

ORDERING: The doors above are made to order and require opening measurements to the nearest 1/16". Door handing not required on Series 7000 doors.

KD Kit — Inside Mount

R7000##K36	Single Screen Door	Up to 36" x 82"	\$373.50
R7001##K36	Single Screen Door	Up to 36" x 96"	\$407.50
R7050##K72	French Door Set	Up to 72" x 82"	\$755.50
R7051##K72	French Door Set	Up to 72" x 96"	\$847.50

Roll-Away[®] Series 7000 KD doors are furnished oversize and require fabrication for final assembly.

R700WHSMPL	Single Door Sample with Frame	16" x 20"	\$213.50
R705WHSMPL	French Door Sample with Frame	28.5" x 20"	\$299.00

FINISHES: White (□), Champagne Beige (■), Bronze (■), Black (■), Desert Sand (■)

SCREEN: Roll-Away[®] Doors are screened with 18 x 14 Stiff Charcoal Fiber.

CUSTOM UNITS CANNOT BE CANCELLED OR RETURNED.

PACKAGING: See [Packaging Chart](#) located in "Shipping Terms and Conditions" to calculate Packaging Fees for Common Carrier orders.

TRU-FRAME®
A name you can build on.

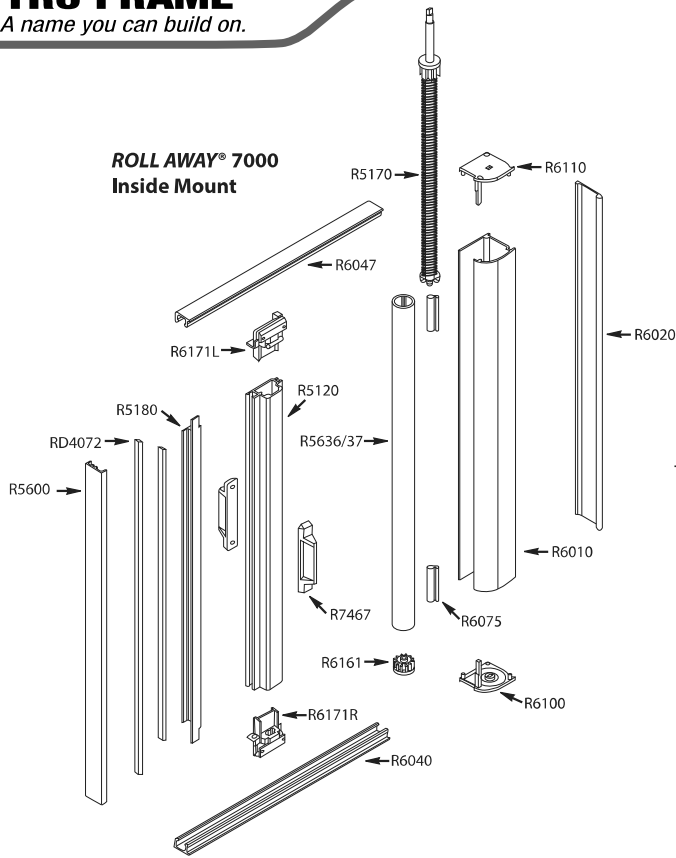

**Series 7000 Inside Mount
Parts List**

R5120##	Drawbar
R5636MF	Tube with Screen 82"
R5637MF	Tube with Screen 96"
R5170	Spring Roller Assembly
R5180##	Astragal
R5600##	Closer Jamb
R6010##	Housing
R6020##	Hinge
R6040##	Sill Track
R6047##	Head Track
R6075BL/WH	PVC Cushion
R6110BL/WH	Housing End Cap - LH
R6100BL/WH	Housing End Cap - RH
R6161BL/WH	Bushing with Pin
R6171(BL/WH)L	Drawbar End Cap Assembly - LH
R6171(BL/WH)R	Drawbar End Cap Assembly - RH
R7467BL/WH	Pull Handle
RD4072	Magnet
##	## - Door color

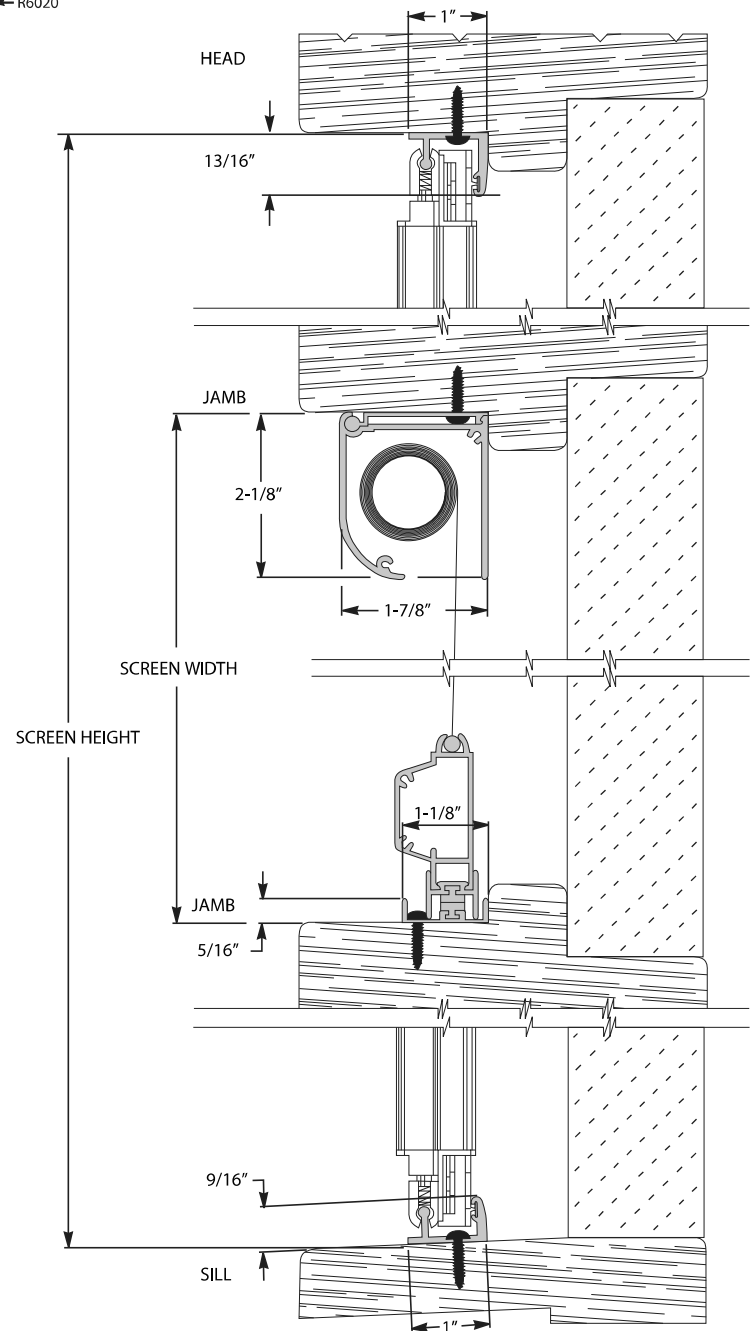

SECTION R

ROLL AWAY[®] Series 7500 Surface Mount

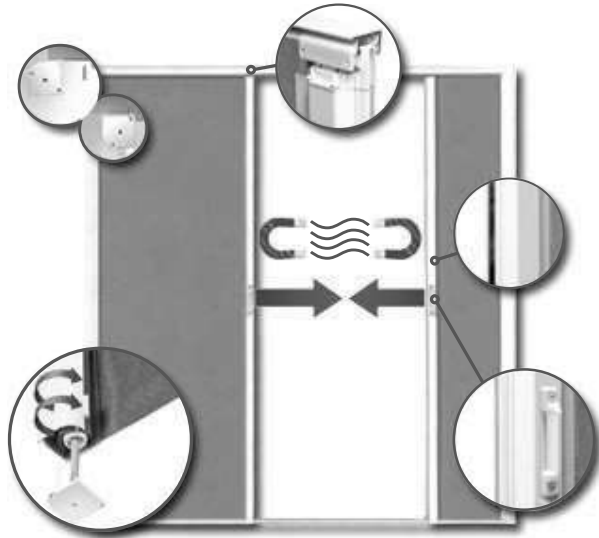

ROLL AWAY[®]
Disappearing Screen Door
With MAGNALOCK[™] SEAL &
Easy-To-Grasp Handle

- 1-7/8" Rounded Housing
- 18 x 14 Stiff Charcoal Fiber
- Best screen Solution for French Doors
- Custom colors available
- Easy-To-Grasp Handle
- Magnalock[™] Seal
- Installs on surface of door opening

Assembled — Surface Mount

LIST PRICE

Product Code	Description	Dimensions	LIST PRICE
R7500##F36	Single Screen Door	Up to 36" x 82"	\$412.00
R7501##F36	Single Screen Door	Up to 36" x 96"	\$446.50
R7550##F72	French Door Set	Up to 72" x 82"	\$846.50
R7551##F72	French Door Set	Up to 72" x 96"	\$938.00

ORDERING: The doors above are made to order and require opening measurements to the nearest 1/16". Door handing not required on Series 7500 doors.

KD Kit — Surface Mount

Product Code	Description	Dimensions	LIST PRICE
R7500##K36	Single Screen Door	Up to 36" x 82"	\$382.50
R7501##K36	Single Screen Door	Up to 36" x 96"	\$416.00
R7550##K72	French Door Set	Up to 72" x 82"	\$772.00
R7551##K72	French Door Set	Up to 72" x 96"	\$862.50

Roll-Away[®] Series 7500 KD doors are furnished oversize and require fabrication for final assembly.

Product Code	Description	Dimensions	LIST PRICE
R750WHSMP	Single Door Sample with Frame	16" x 20"	\$213.50
R755WHSMP	French Door Sample with Frame	28.5" x 20"	\$299.00

FINISHES: White (□), Champagne Beige (■), Bronze (■), Black (■), Desert Sand (■)

SCREEN: Roll-Away[®] Doors are screened with 18 x 14 Stiff Charcoal Fiber.

CUSTOM UNITS CANNOT BE CANCELLED OR RETURNED.

PACKAGING: See [Packaging Chart](#) located in "Shipping Terms and Conditions" to calculate Packaging Fees for Common Carrier orders.

TRU-FRAME®
A name you can build on.

ROLL AWAY® 7500
Surface Mount

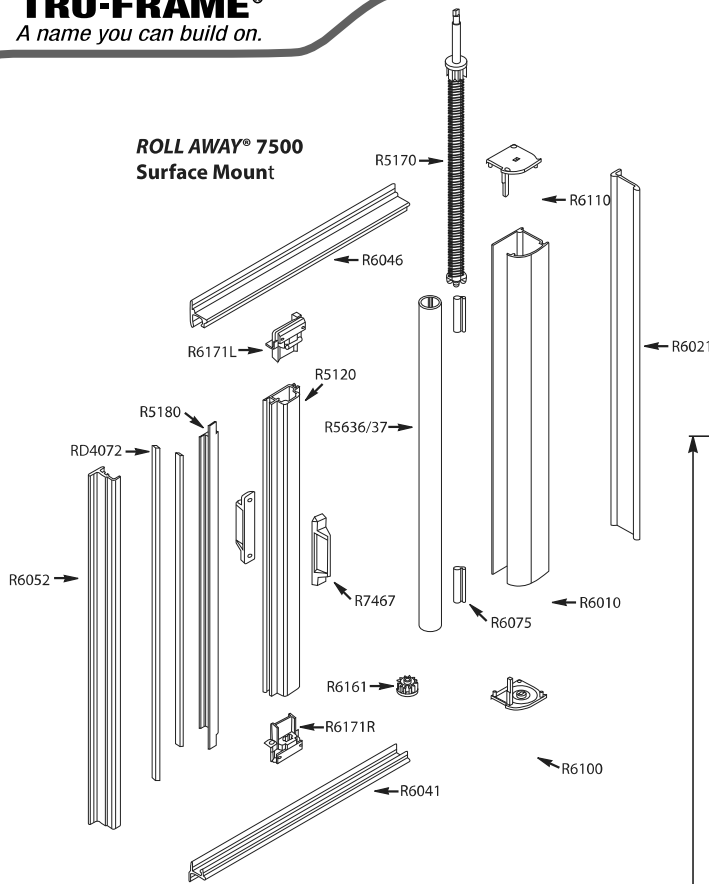

Series 7500 Surface Mount
Parts List

R5120##	Drawbar
R5636MF	Tube with Screen 82"
R5637MF	Tube with Screen 96"
R5170	Spring Roller Assembly
R5180##	Astragal
R6052##	Surface Mount Closer Jamb
R6010##	Housing
R6021##	Surface Mount Closer Jamb
R6041##	Sill Track
R6046##	Head Track
R6075BL/WH	PVC Cushion
R6110BL/WH	Housing End Cap - LH
R6100BL/WH	Housing End Cap - RH
R6161BL/WH	Bushing with Pin
R6171(BL/WH)L	Drawbar End Cap Assembly - LH
R6171(BL/WH)R	Drawbar End Cap Assembly - RH
R7467BL/WH	Pull Handle
RD4072	Magnet
##	## - Door color

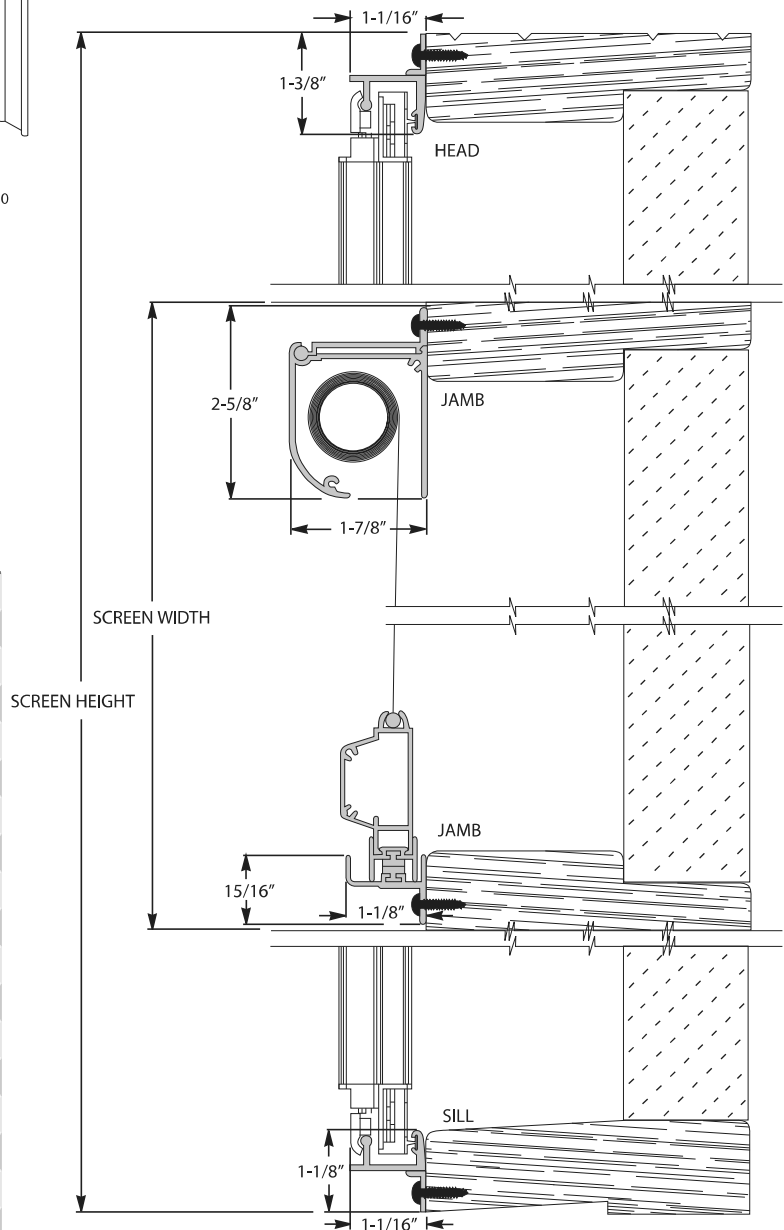

TRU-FRAME®
A name you can build on.

ROLL AWAY® 2000 Series
Fax Number: 888-526-4329

ORDER QUOTE (Check One)

DATE: _____

DEALER: _____

JOB NAME/PO#: _____

ACCOUNT NO.: _____

2-3/8" Canopy
18x14x.009 Brite Bronze Wire
Dual Locking Devices Built Into Drawbar
Constructed of 6063-T-5 Aluminum Alloy

SOLD TO: _____

SHIP TO: _____

ORDERED BY: _____

PHONE NO.: _____

FAX NO.: _____

	QTY	PART NO.	DRAWBAR	FINISH	WIDTH	HEIGHT	NOTES
1							
2							
3							
4							
5							
6							
7							
8							
9							
10							
11							
12							
13							
14							
15							

Example - R21WBZ2424

CLASS	DRAWBAR	FINISH	SCREEN TYPE	SIZE
R	20 = Standard 21 = Reverse	BR = Bronze WH = White	BZ = 18 x 14 x .009 Brite Bronze	Dimensions from price list.

MEASURE TO NEAREST 1/16" FOR OPENING WIDTH AND HEIGHT.
3" CUT-OUTS — MEASURE HEIGHT FROM SILL TO CENTER LINE OF CUT-OUT TO CLEAR CASEMENT FASTENER AND STRIKE PLATE. SPECIFY LEFT OR RIGHT, AS FACING FROM THE INSIDE OUT.



ORDER / QUOTE FORM

R. Lang Company SECTION R

TRU-FRAME®
A name you can build on.

ORDER QUOTE (Check One)

ROLL AWAY® 4000 Series
Fax Number: 888-526-4329

DATE: _____

DEALER: _____

JOB NAME/PO#: _____

ACCOUNT NO.: _____

1-7/8" Canopy
18x14x.013 Rigid Charcoal Fiberglass
Low Profile Designed Housing
Spring Tension Adjuster
Mesh Lock™
Magnetic Guide Locks
Smooth Gliding Weather-Stripped Drawbar

SOLD TO:

SHIP TO:

ORDERED BY: _____

SHIP VIA: _____

PHONE NO.: _____

FAX NO.: _____

	QTY	CLASS	DRAWBAR	FINISH	SCREEN	ACTUAL WIDTH	ACTUAL HEIGHT	NOTES
1								
2								
3								
4								
5								
6								
7								
8								
9								
10								
Sample Part Number								
		R	40	WH	01	24	36	

CLASS	DRAWBAR	FINISH	SCREEN TYPE	SIZE
R	40 = Standard 41 = Reverse	BR = Bronze WH = White BL = Black CB = Cham. Beige DS = Desert Sand	01 = 18 x 14 Rigid Charcoal Fiberglass	Dimensions from price list.

Screen Option: 20 x 20 BetterVue™ Screening.
Measure to nearest 1/16" for Opening Width & Height.



Visit us at www.rollaway.com for more information

ROLL AWAY® 6000/6500 Series
Fax Number: 888-526-4329

ORDER QUOTE (Check One)

DATE: _____

DEALER: _____

JOB NAME/PO#: _____

ACCOUNT NO.: _____

1-7/8" Rounded Housing
18x14x.013 Rigid Charcoal Fiber
Special Wire Options Available
Die Cast Latch System
Optional Inside or Surface Mount
Smooth Gliding Roller System
Custom Colors Available

SOLD TO: _____

SHIP TO: _____

ORDERED BY: _____

SHIP VIA: _____

PHONE NO.: _____

FAX NO.: _____

	QTY	I/O MOUNT	STYLE/SIZE	FINISH	TYPE	WIDTH	HEIGHT	HANDING
1								
2								
3								
4								
5								
6								
7								
8								
9								
10								

CLASS	I/O MOUNT	STYLE/SIZE	FINISH	TYPE	HANDING
R	60 = Inside Mount	00 = Singles up to 36x82	WH = White	F = Assembled	LH = Housing on Left
R	65 = Surface Mount*	01 = Singles up to 36x96	CB = Champ. Beige	K = KD Kit	RH = Housing on Right
		50 = French Drs up to 72x82	BR = Bronze		OX = French Set Right Door Active
		51 = French Drs up to 72x96	BL = Black		XO = French Set Left Door Active
	*Surface mount measured from outside fin to fin.		DS = Desert Sand		**Handing viewed from outside looking in.

SAMPLE PART NUMBERS:

R6000WHF36 = Single door, inside mount, up to 36" x 82", white finish, assembled. (Assembled doors are cut to size & shipped KD)
R6551BLK72 = French door set, surface mount, size 72" x 96", black finish, KD kit. (No specials on KD doors)

For inside mount, provide opening sizes per details on page 42. Surface mount units require an Outside Fin-to-Fin measurement.

When placing order, please specify if Roll-Away® Screen Door will mount on interior of main door, and the handing (as viewed from the exterior).



ORDER / QUOTE FORM

R. Lang Company SECTION R

TRU-FRAME®
A name you can build on.

ORDER QUOTE (Check One)

ROLL AWAY® 7000/7500 Series
Fax Number: 888-526-4329

- 1-7/8" Rounded Housing
- 18x14x.013 Rigid Charcoal Fiber
- Special Wire Options Available
- Optional Inside or Surface Mount
- Custom Colors Available
- Easy-to-Grasp Handle
- Magnalock™ Seal

DATE: _____

DEALER: _____

JOB NAME/PO#: _____

ACCOUNT NO.: _____

SOLD TO:

SHIP TO:

ORDERED BY: _____

SHIP VIA: _____

PHONE NO.: _____

FAX NO.: _____

	QTY	I/O MOUNT	STYLE/SIZE	FINISH	TYPE	WIDTH	HEIGHT	HANDING
1								
2								
3								
4								
5								
6								
7								
8								
9								
10								

<u>CLASS</u>	<u>I/O MOUNT</u>	<u>STYLE/SIZE</u>	<u>FINISH</u>	<u>TYPE</u>	<u>HANDING</u>
R	70 = Inside Mount	00 = Singles up to 36x82	WH = White	F = Assembled	LH = Housing on Left
R	75 = Surface Mount*	01 = Singles up to 36x96	CB = Champ. Beige	K = KD Kit	RH = Housing on Right
		50 = French Drs up to 72x82	BR = Bronze		OX = French Set Right Door Active
		51 = French Drs up to 72x96	BL = Black		XO = French Set Left Door Active
			DS = Desert Sand		**Handing viewed from outside looking in.

SAMPLE PART NUMBERS:

R7000WHF36 = Single door, inside mount, up to 36" x 82", white finish, assembled. (Assembled doors are cut to size & shipped KD)
R7551BLK72 = French door set, surface mount, size 72" x 96", black finish, KD kit. (No specials on KD doors)

For inside mount, provide opening sizes per details on pages 46. Surface mount units require an Outside Fin-to-Fin measurement.

When placing order, please specify if Roll-Away® Screen Door will mount on interior of main door, and the handing (as viewed from the exterior).



Visit us at www.rollaway.com for more information

